

Micromass Quattro Ultima Pt Mass Spectrometer

Operator's Guide



Waters

34 Maple Street
Milford, MA 01757

71500066502 Revision A

NOTICE

The information in this document is subject to change without notice and should not be construed as a commitment by Waters Corporation. Waters Corporation assumes no responsibility for any errors that may appear in this document. This document is believed to be complete and accurate at the time of publication. In no event shall Waters Corporation be liable for incidental or consequential damages in connection with, or arising from, the use of this document.

© 2003 WATERS CORPORATION. ALL RIGHTS RESERVED. THIS DOCUMENT OR PARTS THEREOF MAY NOT BE REPRODUCED IN ANY FORM WITHOUT THE WRITTEN PERMISSION OF THE PUBLISHER.

Micromass and Waters are registered trademarks, and MassLynx is a trademark of Waters Corporation.

All other trademarks or registered trademarks are the sole property of their respective owners.



Safety Information

General

The Micromass Quattro Ultima Pt is designed solely for use as a mass spectrometer; any attempt to use it for any other purpose is liable to damage the instrument and will invalidate its warranty.

The Micromass Quattro Ultima Pt mass spectrometer conforms to European standard EN61010-1:2001, Safety Requirements for electrical equipment for measurement, control and laboratory use - Part 1: General requirements.

The instrument has been designed and tested in accordance with recognized safety standards. If the instrument is used in a manner not specified by the manufacturer, the protection provided by the instrument may be impaired.

Whenever the safety protection of the instrument has been compromised, disconnect the instrument from all power sources and secure the instrument against unintended operation.

The instrument must be installed in such a manner that the user can easily access and isolate the power source.

Safety Symbols

Warnings in this Operator's Guide, or on the instrument, must be observed during all phases of service, repair, installation and operation of the instrument. Failure to comply with these precautions violates the safety standards of the design and intended use of the instrument.

Micromass UK Limited assumes no liability for the user's failure to comply with these requirements.

The following safety symbols may be used in the User's Guide, or on the instrument. A **Caution** is an instruction that draws the user's attention to the risk of injury or death; a **Attention** is an instruction that draws attention to the risk of damage to the instrument.



Caution: This is a general warning symbol, indicating that there is a potential health or safety hazard; the user should refer to this User's Guide for instructions.



Caution: This symbol indicates that hazardous voltages may be present



Caution: *This symbol indicates that hot surfaces may be present.*



Caution: *This symbol indicates that there is danger from corrosive substances.*



Caution: *This symbol indicates that there is danger from toxic substances.*



Caution: *This symbol indicates that there is danger from flammable substances.*



Caution: *This symbol indicates that there is danger from laser radiation.*



Attention: *This is a general caution symbol, indicating that care must be taken to avoid the possibility of damaging the instrument, or affecting its operation.*

Quattro Ultima Pt Mass Spectrometer Information

Intended Use

The Micromass Quattro Ultima Pt Mass Spectrometer can be used as a research tool to deliver authenticated exact mass in both MS and MS-MS mode. It is not for use in diagnostic procedures.

Biological Hazard

When you analyze physiological fluids, take all necessary precautions and treat all specimens as potentially infectious. Precautions are outlined in “CDC Guidelines on Specimen Handling,” *CDC – NIH Manual*, 1984.

Calibration

Follow acceptable methods of calibration with pure standards to calibrate methods. Use a minimum of five standards to generate a standard curve. The concentration range should cover the entire range of quality-control samples, typical specimens, and atypical specimens.

Quality Control

Routinely run three quality-control samples. Quality-control samples should represent subnormal, normal, and above-normal levels of a compound. Ensure that quality-control sample results are within an acceptable range, and evaluate precision from day to day and run to run. Data collected when quality-control samples are out of range may not be valid. Do not report this data until you ensure that system performance is acceptable.

Table of Contents

Chapter 1

Instrument Description	29
1.1 Overview	29
1.2 Vacuum System	30
1.3 Ionization Techniques.....	31
1.4 Sample Inlet.....	32
1.5 MS Operating Modes	32
1.6 MS-MS Operating Modes	33
1.7 Data System.....	38
1.8 Front Panel Connections	39
1.9 Front Panel Controls and Indicators	40
1.10 Rear Panel Connections	43
1.11 Internal Layout.....	47

Chapter 2

Routine Procedures	51
2.1 Start Up Following a Complete Shutdown	51
2.1.1 Preparation	51
2.1.2 Pumping	54
2.1.3 Measuring the Analyzer Pressure	56
2.1.4 Using the Instrument	56
2.2 Start Up Following Overnight Shutdown.....	57
2.2.1 Preparation for ElectroSpray Operation	57
2.2.2 Preparation for Ion Sabre APcI Operation	61
2.2.3 Operate	64
2.3 Automatic Pumping and Vacuum Protection	64
2.3.1 Overview	64

2.3.2	Protection	65
2.4	Tuning	66
2.5	Calibration	66
2.6	Data Acquisition	66
2.7	Data Processing	66
2.8	Setting-Up for MS-MS Operation	67
2.8.3	Parent Ion Selection	67
2.8.4	Fragmentation	68
2.9	Shutdown Procedures	69
2.9.1	Emergency Shutdown	69
2.9.2	Overnight Shutdown	69
2.9.3	Complete Shutdown	70
2.10	Automatic Startup and Shutdown - The Shutdown Editor 71	
2.10.1	General	71
2.10.2	The Shutdown Editor Menu Bar	72
2.10.3	The Shutdown Editor Tool Bar	76
2.10.4	The Shutdown Editor Shutdown Page	76
2.10.5	The Shutdown Editor Auto Control Tasks Page	82
2.10.6	Running Startup and Shutdown Task Files	85

Chapter 3

Tuning	87	
3.1	Overview	87
3.2	The Tune Page	88
3.3	Changing Tune Parameter Settings	89
3.4	Source Voltages	89
3.5	Printing Tune Information	90
3.6	Experimental Record	91
3.7	Saving and Restoring Tune Parameter Settings	91

3.8	Modifying the Tune Peak Display	92
3.9	Changing the Display	94
3.9.1	Customize Plot Appearance	94
3.9.2	Trace	95
3.9.3	Intensity	95
3.9.4	Grid	96
3.10	AutoTune	96
3.11	Ion Mode	98
3.12	Scope Parameters	98
3.13	Gas Controls	99
3.14	Ramp Controls	99
3.14.5	Cone Voltage Ramp	99
3.14.6	Collision Energy Ramp	100
3.15	Resetting the Zero Level	101
3.16	Controlling Read-Backs	102

Chapter 4

Data Acquisition	103	
4.1	Starting an Acquisition	103
4.2	Starting an Acquisition from the Tune Page	103
4.3	Multiple Sample Data Acquisition	107
4.4	Monitoring an Acquisition	110
4.5	Instrument Data Thresholds	113
4.6	System Manager	118
4.7	Stopping an Acquisition	118
4.8	The MS Method Editor	118

Chapter 5

Mass Calibration	159	
5.1	Introduction	159
5.2	Overview	159

5.2.1	Calibration Types	160
5.2.2	The Calibration Process	160
5.3	ElectroSpray Calibration	161
5.3.3	Introduction	161
5.3.4	Preparing for Calibration	161
5.3.5	Calibration Options	163
5.3.6	Selecting Parameters	164
5.3.7	Performing a Calibration	168
5.3.8	Checking the Calibration	174
5.3.9	ElectroSpray Calibration with PEG	182
5.4	Atmospheric Pressure Chemical Ionization Calibration	183
5.4.1	Introduction	183
5.4.2	Preparing for Calibration	185
5.4.3	Calibration Options	185
5.4.4	Selecting Calibration Parameters	186
5.4.5	Performing a Calibration	186
5.4.6	Calibration Failure	197
5.4.7	Incorrect Calibration	199
5.4.8	Manual Editing of Peak Matching	200
5.4.9	Saving the Calibration	200
5.4.10	Manual Verification	200

Chapter 6

ElectroSpray	203
6.1 Introduction	203
6.1.1 Post-column Splitting	205
6.1.2 MegaFlow ElectroSpray	206
6.2 Operation	207
6.2.1 Checking the ESI Probe	208
6.2.2 Obtaining an Ion Beam	210

6.2.3	Megaflow Hints	217
6.2.4	Removing the Probe	218
6.3	Sample Analysis and Calibration	218
6.3.5	General Information	218
6.4	Chromatographic Interfacing	220
6.4.1	LC-MS Sensitivity Enhancement	221

Chapter 7

Atmospheric Pressure Chemical Ionization	223	
7.1	Introduction	223
7.2	Preparation	225
7.2.1	Checking the Probe	226
7.3	Obtaining an Ion Beam	227
7.4	Calibration	229
7.5	Hints for Sample Analysis	229
7.5.2	Tuning for General Qualitative Analysis	229
7.5.3	Specific Tuning for Maximum Sensitivity	230
7.6 Removing the Probe	231

Chapter 8

Maintenance and Fault Finding	233	
8.1	Introduction	233
8.2	Cooling Fans and Air Filters	234
8.3	The Vacuum System	234
8.3.1	Vacuum Leaks	235
8.3.2	Pirani Gauge	235
8.3.3	Active Inverted Magnetron Gauge	235
8.3.4	Gas Ballasting and Rotary Pump Oil Recirculation	236
8.3.5	Oil Mist Filter	237
8.3.6	Foreline Trap	237
8.3.7	Rotary Pump Oil	238

8.4	The Source	239
8.4.1	Overview	239
8.4.2	Cleaning the Cone Gas Nozzle and Sample Cone	240
8.4.3	Removing and Cleaning the Ion Block	245
8.4.4	Removing and Cleaning the Ion Tunnel Assembly	249
8.4.5	Reassembling and Checking the Source	251
8.4.6	The Corona Discharge Pin	253
8.5	The ElectroSpray Probe	254
8.5.1	Overview	254
8.5.2	Renewal of the Stainless Steel Sample Capillary	256
8.6	The APcI Probe	258
8.6.1	Cleaning the Probe Tip	258
8.6.2	Renewing the Probe Tip Heater	259
8.6.3	Renewing the Fused Silica Capillary	260
8.7	The Analyzer	262
8.8	The Detector	262
8.9	Electronics	263
8.9.4	Fuses	263
8.10	Fault Finding Check List	265
8.10.1	No Beam	265
8.10.2	Unsteady or Low Intensity Beam	265
8.10.3	Ripple	265
8.10.4	High Noise Level in MRM Analyses	266
8.10.5	High Backpressure	267
8.10.6	General Loss of Performance	268
8.11	Cleaning Materials	268
8.12	Preventive Maintenance Check List	269
8.12.1	Weekly	269
8.12.2	Monthly	270
8.12.3	Three-Monthly	270

8.12.4 Four-Monthly	270
---------------------------	-----

Appendix A

Reference Information	271
1.1 Overview	271
1.2 Editing a Reference File	272
1.3 Positive Ion	273
1.3.1 Horse Heart Myoglobin	274
1.3.2 Polyethylene Glycol	275
1.3.3 Sodium Iodide and Caesium Iodide Mixture	276
1.3.4 Sodium Iodide and Rubidium Iodide Mixture	276
1.4 Negative Ion	277
1.4.5 Horse Heart Myoglobin	277
1.4.6 Mixture of Sugars	278
1.4.7 Sodium Iodide and Caesium Iodide (or Rubidium Iodide) Mixture	278
1.5 Preparation of Calibration Solutions	279
1.5.8 PEG + Ammonium Acetate for Positive Ion ElectroSpray and APcI ...	279
1.5.9 PEG + Ammonium Acetate for Positive Ion ElectroSpray (Extended Mass Range) 279	
1.5.10 Sodium Iodide Solution for Positive Ion ElectroSpray	280
1.5.11 Sodium Iodide Solution for Negative Ion ElectroSpray	280

Index

List of Figures

1-1	Micromass Quattro Ultima Pt Ion Optics	29
1-2	MS Operating Modes	32
1-3	MS-MS Mode - Obtaining a Daughter Ion Spectrum	34
1-4	Example of a Daughter Ion Spectrum	35
1-5	MS-MS Mode - Obtaining a Parent Ion Spectrum	36
1-6	MS-MS Mode - Parent Ion Spectrum Example	36
1-7	Multiple Reaction Monitoring	37
1-8	Producing a Chromatogram in MRM mode	37
1-9	Constant Neutral Loss Spectrum	38
1-10	Front Panel Connections	39
1-11	Front Panel Controls and Indicators	40
1-12	Divert/Injection Valve	42
1-13	Event Out Connections	44
1-14	Rear Panel Connections	45
1-15	Internal Layout of Electronics	47
1-16	Main Electronics Modules	48
1-17	Main Internal Mechanical Components	50
2-1	Edwards Rotary Pump	51
2-2	Gas/Water Connections	52
2-3	Rear Exhaust and Peripheral Connections	53
2-4	Source Isolation Valve	55
2-5	Preparation for Electrospray Operation	57
2-6	Replacing the Corona Discharge Pin For ESI	59
2-7	Preparation for APCI	61
2-8	Inserting Corona Discharge Pin for APCI	62

2-9	File Menu	72
2-10	View Menu	73
2-11	Control List Menu	74
2-12	Shutdown Log Menu	74
2-13	Shutdown/Startup Log Window	75
2-14	Shutdown Log Parameters	75
2-15	Shutdown Editor Shutdown Page	77
2-16	Shutdown Error Configuration	79
2-17	Gas Threshold Configuration	80
2-18	Event In Configuration	81
2-19	Shutdown Editor Auto Control Tasks	82
3-1	Analyser Tune Page	87
3-2	Toolbar and Tune Page Parameters	88
3-3	Source Voltages	90
3-4	Autotune Dialog	96
3-5	Autotune Setup	97
3-6	Scope Parameters	99
3-7	Cone Ramp Dialog	100
3-8	Collision Energy Ramp	101
3-9	Readbacks Dialog	102
4-1	Start Acquisition Dialog	104
4-2	Sample List Options	108
4-3	Quantify Samples Dialog	109
4-4	Scan Report Window	111
4-5	Spectrum Real Time Update	112
4-6	Instrument Threshold Settings	113
4-7	Effects of Changing Threshold Settings	116
4-8	System Manager Dialog	118
4-9	Function List Dialog	119
4-10	SIR Functions	120

4-11	Solvent Delay Dialog	123
4-12	Analog Data Dialog	124
4-13	Scan Function Editor.....	125
4-14	Cone Ramp Dialog.....	126
4-15	SIR Function Setup Dialog	128
4-16	Setting Up MS-MS Scanning Functions	130
4-17	Collision Ramp Dialog.....	132
4-18	MRM Editor Dialog	133
4-19	Survey Scan Dialog: Survey and MSMS Template Pages.....	134
4-20	Survey Scan Dialog: MS to MSMS Template Page	135
4-21	Survey Scan Dialog: MSMS to MS Page	138
4-22	Survey Scan Dialog: Include Page.....	140
4-23	Include Masses Dialog	143
4-24	Survey Scan Dialog: Exclude Page.....	145
4-25	Exclude Mass Dialog	147
4-26	Survey Scan Dialog: Collision Energy Page.....	148
4-27	Collision Energy Profile.....	151
4-28	Collision Energy Dialog.....	152
4-29	Modify Charge State Dialog	153
4-30	Charge State Mass Dialog	154
4-31	Survey Scan Dialog: Adduct Page	156
4-32	Adduct Mass Dialog.....	157
4-33	Function Switching Status	157
5-1	Instrument Threshold Settings Dialog	162
5-2	Calibration Dialog.....	163
5-3	Automatic Calibration Check Dialog.....	164
5-4	Calibration Parameters Dialog	165
5-5	Mass Measure Dialog.....	167
5-6	Automatic Calibration Dialog.....	168
5-7	Calibration Acquisition Setup Dialog.....	170
5-8	Calibration Report Example.....	173

5-9	Display Verification Graphs Dialog.....	174
5-10	Calibration Report Display	175
5-11	Calibration Report - Peak Matching	176
5-12	Automatic Calibration Dialog.....	180
5-13	Calibration Acquisition Setup Dialog.....	181
5-14	Calibration Verification Report.....	182
5-15	PEG Spectrum showing Excess of Doubly Charged Ions	183
5-16	PEG 200 to PEG 1000 Spectrum	184
5-17	Automatic Calibration Dialog.....	187
5-18	Calibration Acquisition Setup Dialog.....	188
5-19	Calibration Dialog.....	190
5-20	Display Calibration Graphs Dialog.....	191
5-21	Calibration Report - Peak Matching	192
5-22	Calibration Report - Peak Matching	193
5-23	Calibration Report - Printout.....	194
5-24	Display Verification Graphs Dialog.....	201
5-25	Calibration Report for Verification	202
6-1	Electrospray Ionization	203
6-2	Post-column Splitting.....	205
6-3	Changing Between Flow Modes	206
6-4	Source Setup for Electrospray.....	207
6-5	Probe Tip Capillary Fine Adjustment	209
6-6	Start Acquisition Dialog.....	211
6-7	Probe Adjustment.....	211
6-8	Gas Flow Controls	212
6-9	Cone Gas	214
7-1	APCI.....	223
7-2	Source Setup for APCI.....	225
7-3	Probe Adjustments	228
7-4	Probe Removal from Source	232

8-1	Rotary Pump Maintenance.....	236
8-2	Source Dismantling for Sample Cone Access	241
8-3	Sample Cone and Gas Nozzle.....	242
8-4	Sample Cone Removal.....	244
8-5	Ion Block Cover Plate	246
8-6	Ion Block Removal	247
8-7	Removing and Cleaning Ion Block Assembly	249
8-8	Differential Aperture Plate O-Ring.....	250
8-9	Ion Tunnel Assembly Springs.....	252
8-10	Renewal of Stainless Steel Sample Capillary	256
8-11	Renewing the Probe Tip Heater	259
8-12	Renewing the Fused Silica Capillary	260

Preface

The *Micromass Quattro Ultima Pt Mass Spectrometer* is intended for a wide variety of users whose familiarity with Mass Spectrometers, computers and software ranges from novice to expert. This guide describes the basics of how to Startup the instrument, obtain an Ion Beam, Calibrate and Acquire Data using MassLynx Software, and maintain the instrument.

Organization

This guide contains the following:

Chapter 1 describes how to use the manual in conjunction with the instrument

Chapter 2 gives a brief description and overview of the instrument

Chapter 3 describes the routine procedures that are required to Startup and Shutdown the Instrument

Chapter 4 describes how to calibrate the instrument and subsequently acquire data.

Chapter 5 describes the use of the instrument in different modes with optional accessories.

Chapter 6 describes Maintenance and Fault Finding for the instrument.

Chapter 7 describes the MassLynx user interface.

Appendix A shows a copy of the laser hazard safety awareness certificate.

Appendix B describes the risks, hazards and preventive measures associated with servicing the instrument..

Related Documentation

Waters Licenses, Warranties, and Support: Provides software license and warranty information, describes training and extended support, and tells how Waters handles shipments, damages, claims, and returns.

Online Documentation

MassLynx Help: Describes all MassLynx windows, menus, menu selections, and dialog boxes for the base software and software options. Also included are help Files

on Inlet Control, Interfacing, Security and any application software that may have been purchased.

MassLynx ReadMe File: Describes product features and enhancements, helpful tips, installation and/or configuration considerations, and changes since the previous version.

Printed Documentation for Base Product

Instrument User's Guides: Provides an introduction to then running and maiontenance of the Instrument. Also basic instructions on how to acuire dat and calibrate and instrument.

MassLynx User's Guide: Provides a comprehensive introduction to the MassLynx software. Describes the basics of how to use MassLynx software to acquire data develop an acquisition method, review and process results, and print a report.

MassLynx Interfacing Guide: Provides information on how to interface MassLynx with other Software appliactions.

MassLynx Inlet Control Guide: Provides information on how to install and run Autosamplers, LC and GC systems, UV detectors using MassLynx.

MassLynx Security User's Guide: Describes how security to your MassLynx system..

Printed Documentation for Software Options

QuanLynx User's Guide: Describes the procedures for installing, configuring and using QuanLync Software.

OpenLynx User's Guide: Describes the procedures for installing, configuring and using OpenLynx Software.

FractionLynx User's Guide: Describes the procedures for installing, configuring and using FractionLynx Software.

MetaboLynx User's Guide: Describes the procedures for installing, configuring and using MetaboLynx Software.

BioLynxLynx and ProteinLynx User's Guide: Describes the procedures for installing, configuring and using BioLynxLynx and ProteinLynx Software.

MicrobeLynx User's Guide: Describes the procedures for installing, configuring and using MicrobeLynx Software.

NeoLynx User's Guide: Describes the procedures for installing, configuring and using NeoLynx Software.

Documentation on the Web

Related product information and documentation can be found on the World Wide Web. Our address is <http://www.waters.com/micromass>.

Documentation Conventions

The following conventions can be used in this guide:

Convention	Usage
Bold	Bold indicates user action such as keys to press, menu selections, and commands. For example, "Click Next to go to the next page."
<i>Italic</i>	Italic indicates information that you supply such as variables. It also indicates emphasis and document titles. For example, "Replace <i>file_name</i> with the actual name of your file."
Courier	Courier indicates examples of source code and system output. For example, "The SVRMGR> prompt appears."
Courier Bold	Courier bold indicates characters that you type or keys you press in examples of source code. For example, "At the LSNRCTL> prompt, enter set password oracle to access Oracle."
Keys	The word <i>key</i> refers to a computer key on the keypad or keyboard. <i>Screen keys</i> refer to the keys on the instrument located immediately below the screen. For example, "The A/B screen key on the 2414 Detector displays the selected channel."
...	Three periods indicate that more of the same type of item can optionally follow. For example, "You can store <i>filename1</i> , <i>filename2</i> , ... in each folder."
>	A right arrow between menu options indicates you should choose each option in sequence. For example, "Select File > Exit " means you should select File from the menu bar, then select Exit from the File menu.

Notes

Notes call out information that is helpful to the operator. For example:

Note: *Record your result before you proceed to the next step.*

Attentions

Attentions provide information about preventing damage to the system or equipment. For example:



Attention: *To avoid damaging the detector flow cell, do not touch the flow cell window.*

Cautions

Cautions provide information essential to the safety of the operator. For example:



Caution: *To avoid burns, turn off the lamp at least 30 minutes before removing it for replacement or adjustment.*



Caution: *To avoid electrical shock and injury, unplug the power cord before performing maintenance procedures.*



Caution: *To avoid chemical or electrical hazards, observe safe laboratory practices when operating the system.*



Caution: *Operating the source without the source enclosure will result in solvent vapor escape.*



Caution: *Strong acid causes burns. Carry out this procedure in a fume cupboard using protective equipment.*



Caution: *Cleaning the source requires the use of solvents and chemicals which may be flammable.*

Chapter 1

Instrument Description

1.1 Overview

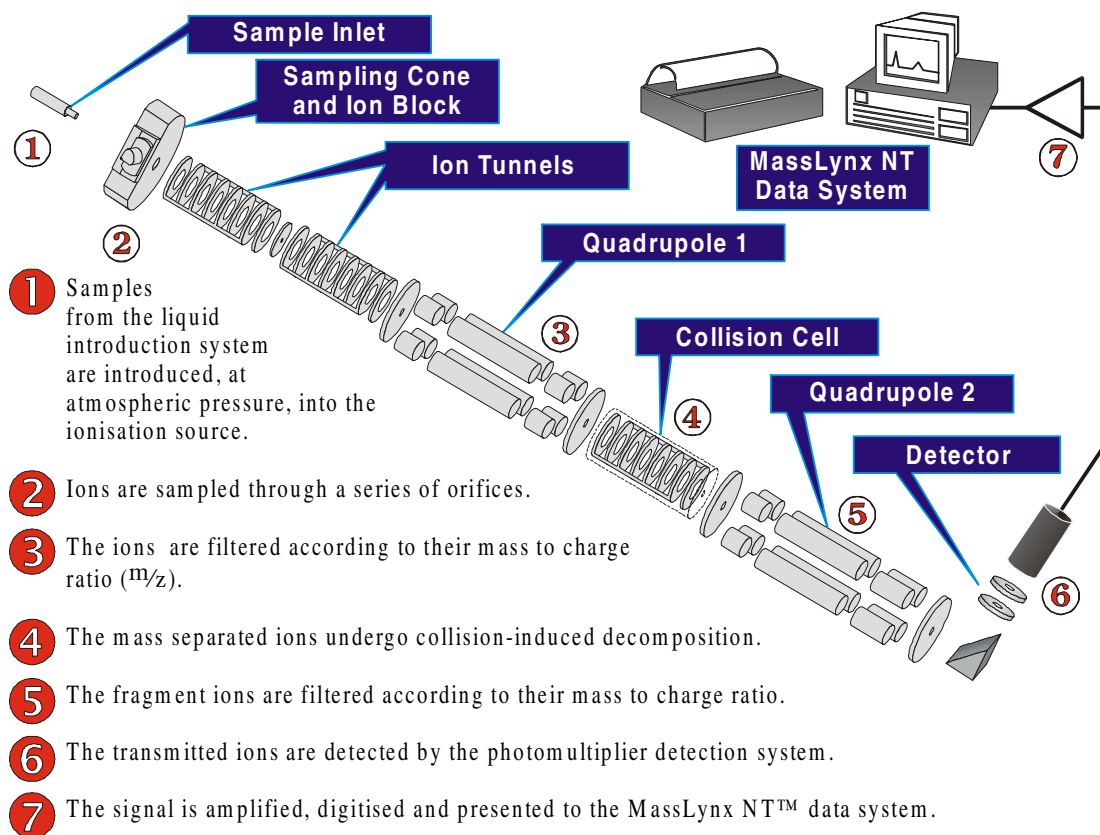

Figure 1-1 Micromass Quattro Ultima Pt Ion Optics

The Micromass Quattro Ultima Pt is a high performance, bench-top, tandem-quadrupole mass spectrometer designed for routine LC-MS-MS operation. Quattro Ultima Pt may be coupled to:

- A HPLC system with, or without, an autosampler.
- An infusion pump.
- A syringe pump.

Ionization takes place in the source at atmospheric pressure. These ions are sampled through a series of orifices and ion optics into the first quadrupole where they are filtered according to their mass to charge ratio (m/z).

The mass separated ions then pass into the ion tunnel collision cell, with axial field, where they either undergo Collision Induced Decomposition (CID), or pass unhindered to the second quadrupole. The fragment ions are then mass analyzed by the second quadrupole. Finally, the transmitted ions are detected by a conversion dynode, phosphor, and photomultiplier detection system. The output signal is amplified, digitized, and presented to the data system.

1.2 Vacuum System

Vacuum is achieved using two direct drive rotary pumps, and two turbomolecular pumps.

The rotary pumps are mounted on the floor external to the instrument. The E1M18 pumps the ion source block, while the E2M28 pumps the first ion tunnel and also backs the turbomolecular pumps. The E1M18 has an automatic gas ballast control valve mounted in the oil return line from the mist filter. This solenoid valve is opened whenever the E1M18 is switched on, allowing continuous recirculation of the pump oil provided that the manual gas ballast valve on the pump is left open.

The turbomolecular pumps evacuate the analyzer and ion transfer region. These pumps are both water-cooled.

Vacuum measurement is by an active inverted magnetron (Penning) gauge for the analyzer and a Pirani gauge for the gas cell. The Penning gauge acts as a vacuum switch, switching the instrument out of the OPERATE mode if the pressure is too high.

The speed of each turbomolecular pump is monitored and the system is fully interlocked to provide adequate protection in the event of a fault in the vacuum system, a failure of the power supply, or vacuum leaks.

1.3 Ionization Techniques

Two atmospheric pressure ionization techniques are available:

- Atmospheric Pressure Chemical Ionization.
- ElectroSpray.

Atmospheric Pressure Chemical Ionization

Atmospheric pressure chemical ionization (APCI) generally produces protonated, or deprotonated molecular ions from the sample via a proton transfer (positive ions), or proton abstraction (negative ions) mechanism. The sample is vaporized in a heated nebuliser before emerging into a cloud of solvent ions formed within the atmospheric source by a corona discharge. Proton transfer or abstraction then takes place between the solvent ions and the sample. Eluent flows up to 2 ml/min can be accommodated without splitting the flow.

ElectroSpray

ElectroSpray ionization (ESI) takes place as a result of imparting a strong electrical field to the eluent flow as it emerges from the nebuliser, producing an aerosol of charged droplets. These undergo a reduction in size by solvent evaporation until they have attained a sufficient charge density to allow sample ions to be ejected from the surface of the droplet (“ion evaporation”).

A characteristic of ESI spectra is that ions may be singly or multiply charged. Since the mass spectrometer filters ions according to their mass-to-charge ratio, compounds of high molecular weight can be determined if multiply charged ions are formed.

Eluent flows up to 1 ml/min can be accommodated, although it is often preferable with ElectroSpray ionization to split the flow such that 100 to 200 μ l/min of eluent enters the mass spectrometer.

NanoFlow ElectroSpray

The optional NanoFlow interface allows ElectroSpray ionization to be performed in the flow rate range 5 to 1000 nl/min.

For a given sample concentration, the ion currents observed in NanoFlow are comparable to those seen in normal flow rate ElectroSpray. Large sensitivity gains are therefore observed when similar scan parameters are used, due to the large reductions in sample consumption.

1.4 Sample Inlet

Sample is introduced from a suitable liquid pumping system, along with the nebulising gas, to either the APCI probe, or the ElectroSpray probe. For NanoFlow ElectroSpray, metal coated glass capillaries allow the lowest flow rates to be obtained while fused silica capillaries are used for flow injection analyses, or for coupling to nano-HPLC.

1.5 MS Operating Modes

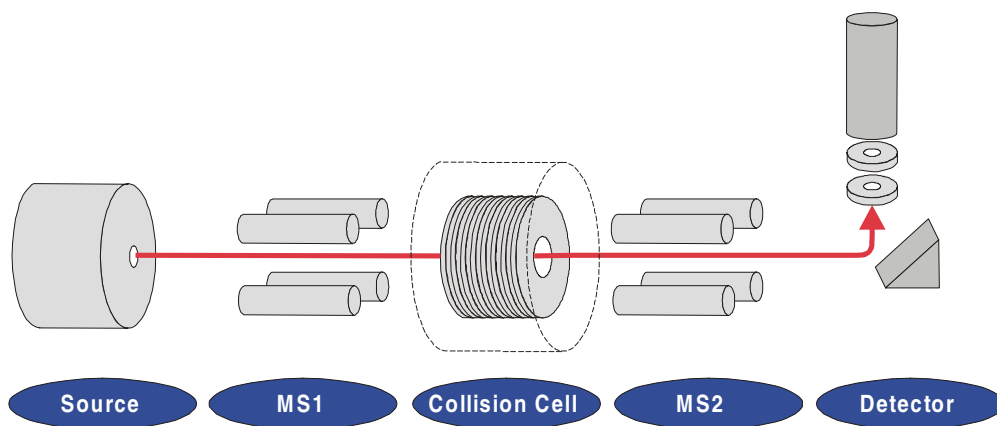

Figure 1-2 MS Operating Modes

	MS1	Collision Cell	MS2
MS	Resolving	Radio Frequency (RF) only (pass all masses)	
MS2	RF only (pass all masses)		Resolving

The MS1 mode, in which MS1 is used as the mass filter, is the most common and most sensitive method of performing MS analysis. This is directly analogous to using a single-quadrupole mass spectrometer.

The MS2 mode of operation is used, with collision gas present, when switching rapidly between MS and MS-MS operation. It also provides a useful tool for instrument tuning and calibration prior to MS-MS analysis, and for fault diagnosis.

1.6 MS-MS Operating Modes

The basic features of the four common MS-MS scan functions are summarized below.

	MS1	Collision Cell	MS2
Daughter Ion Spectrum	Static (parent mass selection)	RF only (pass all masses)	Scanning
Parent Ion Spectrum	Scanning		Static (daughter mass selection)
Multiple Reaction Monitoring	Static (parent mass selection)		Static (daughter mass selection)
Constant Neutral Loss Spectrum	Scanning (synchronized with MS2)		Scanning (synchronized with MS1)

The Daughter Ion Spectrum

This is the most commonly used MS-MS scan mode. Typical applications are:

- Structural elucidation (e.g. peptide sequencing).
- Method development for MRM screening studies:

Identification of daughter ions for use in MRM “transitions”.

Optimization of CID tuning conditions to maximize the yield of a specific daughter ion to be used in MRM analysis.

Example:

Daughters of the specific parent at m/z 609 from reserpine, in ElectroSpray positive ion mode.

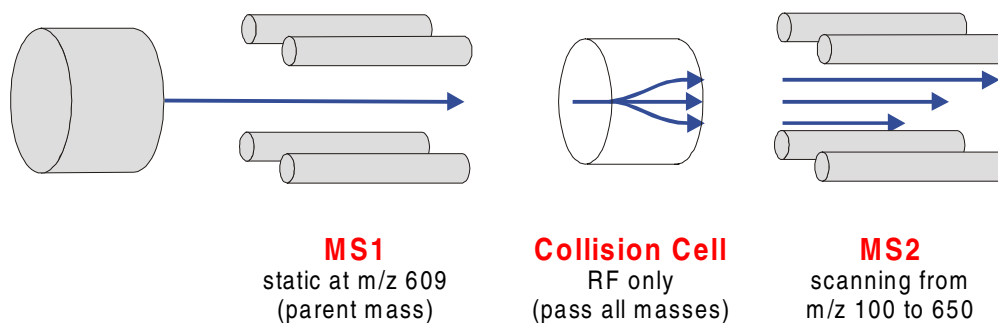

Figure 1-3 MS-MS Mode - Obtaining a Daughter Ion Spectrum

The result:

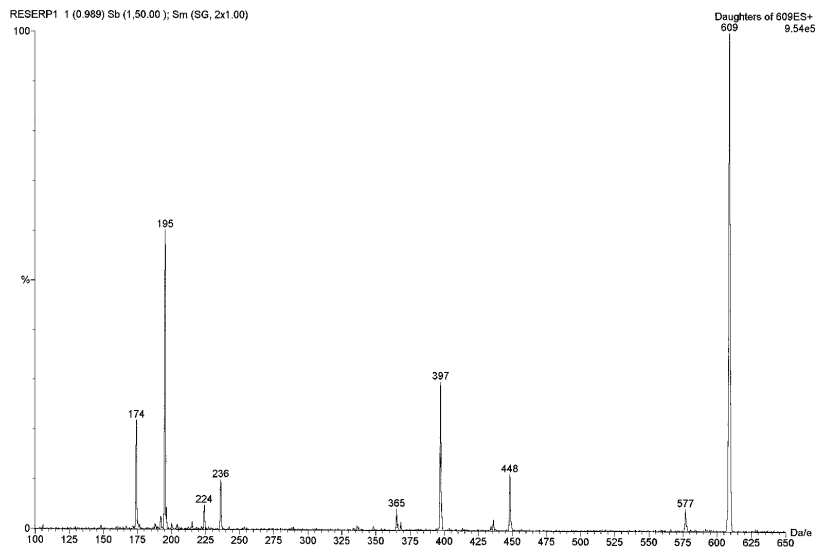

Figure 1-4 Example of a Daughter Ion Spectrum

The Parent Ion Spectrum

Typical application:

- Structural elucidation.

Complementary or confirmatory information (for daughter scan data).

Example:

Parents of the specific daughter ion at m/z 195 from reserpine, in ElectroSpray positive ion mode.

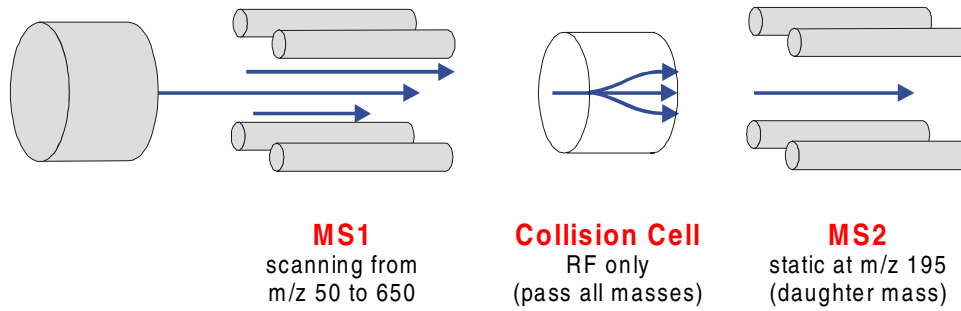

Figure 1-5 MS-MS Mode - Obtaining a Parent Ion Spectrum

The result:

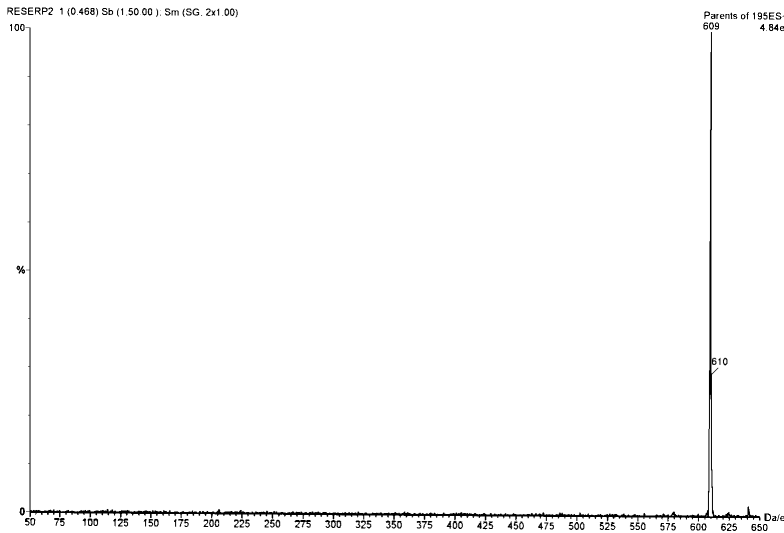

Figure 1-6 MS-MS Mode - Parent Ion Spectrum Example

MRM: Multiple Reaction Monitoring

This mode is the MS-MS equivalent of SIR (Selected Ion Recording). As both MS1 and MS2 are static, this allows greater “dwell time” on the ions of interest and therefore better sensitivity (~100×) compared to scanning MS-MS.

Typical application:

- Rapid screening of “dirty” samples for known analytes.

Drug metabolite and pharmacokinetic studies.
 Environmental, for example, pesticide and herbicide analysis.
 Forensic or toxicology, for example, screening for target drugs in sport.

Example:

Monitor the transition (specific fragmentation reaction) m/z 609 \rightarrow 195 for reserpine in ElectroSpray positive ion LC-MS-MS mode.

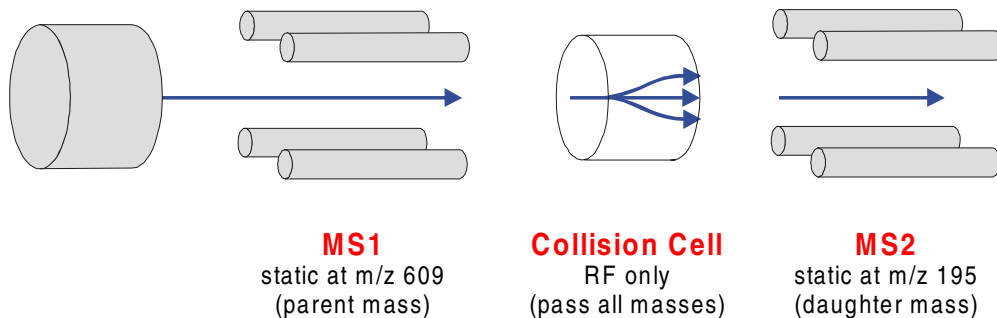

Figure 1-7 Multiple Reaction Monitoring

The result:

MRM does not produce a spectrum as only one transition is monitored. As in SIR, a chromatogram is produced.



- LC-MRM**
- High specificity
 - Good signal/noise

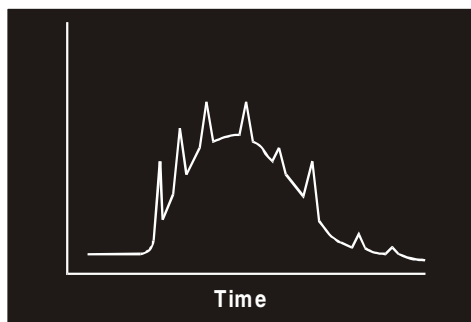

- LC-MS**
- Low specificity
 - Poor signal/noise

Figure 1-8 Producing a Chromatogram in MRM mode

The Constant Neutral Loss Spectrum

The loss of a specific neutral fragment, or functional group, from an unspecified parent, or parents.

Typical applications:

- Screening mixtures, for example, during neonatal screening, for a specific class of compound that is characterized by a common fragmentation pathway.

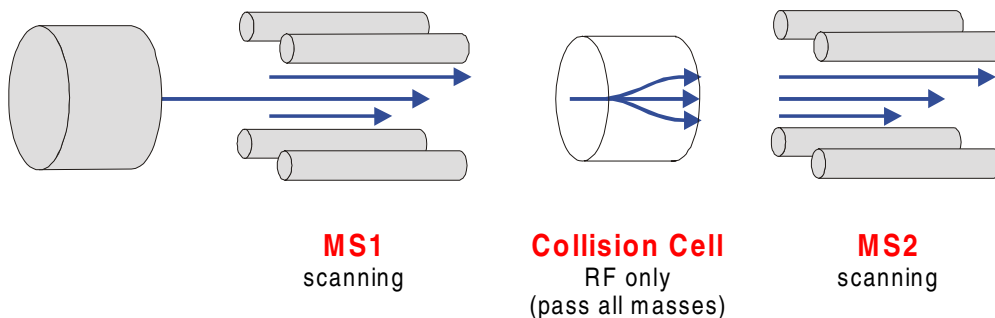

Figure 1-9 Constant Neutral Loss Spectrum

The scans of MS1 and MS2 are synchronized. When MS1 transmits a specific parent ion, MS2 “looks” to see if that parent loses a fragment of a certain mass. If it does, it registers at the detector.

The result:

The “spectrum” shows the masses of all parents that actually lost a fragment of a certain mass.

1.7 Data System

The PC-based data system, incorporating MassLynx NT™ software, controls the mass spectrometer detector and, if applicable, the HPLC system, autosampler, syringe pump, divert valve, or injector valve.

The PC uses the Microsoft Windows NT graphical environment with color graphics, and provides for full user interaction using either the keyboard or mouse.

MassLynx NT provides full control of the system including setting up and running selected HPLC systems, tuning, acquiring data and data processing.

Analog inputs can be read by the data system so that, where applicable, a trace from a conventional LC detector (for example UV or fluorescence) can be stored simultaneously with the acquired mass spectral data. A further option is the ability to acquire UV photodiode array detector data.

Comprehensive information about MassLynx NT is found in the *MassLynx NT User's Guide*.

1.8 Front Panel Connections

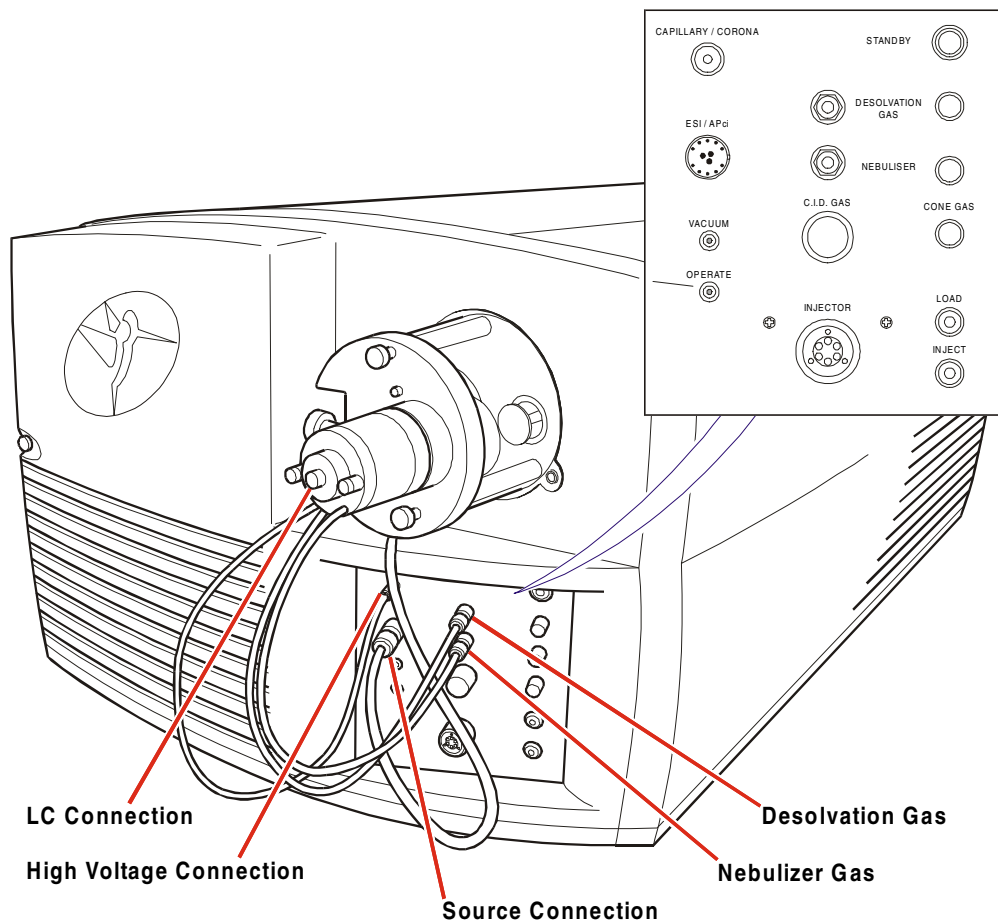

Figure 1-10 Front Panel Connections

Desolvation Gas and Probe Nebuliser Gas

The PTFE gas lines for the desolvation gas and probe nebuliser gas are connected to the front of the instrument using threaded metal fittings.

Capillary/Corona

The electrical connection for the ESI capillary, or the APcI discharge pin is via the coaxial high voltage connector.

ESI/APcI

The electrical connection for the APcI probe, or the ESI heater is via the multi-way connector. This is removed from the front panel by pulling on the metal sleeve of the plug. Both the ElectroSpray and APcI heaters use this connector.

1.9 Front Panel Controls and Indicators

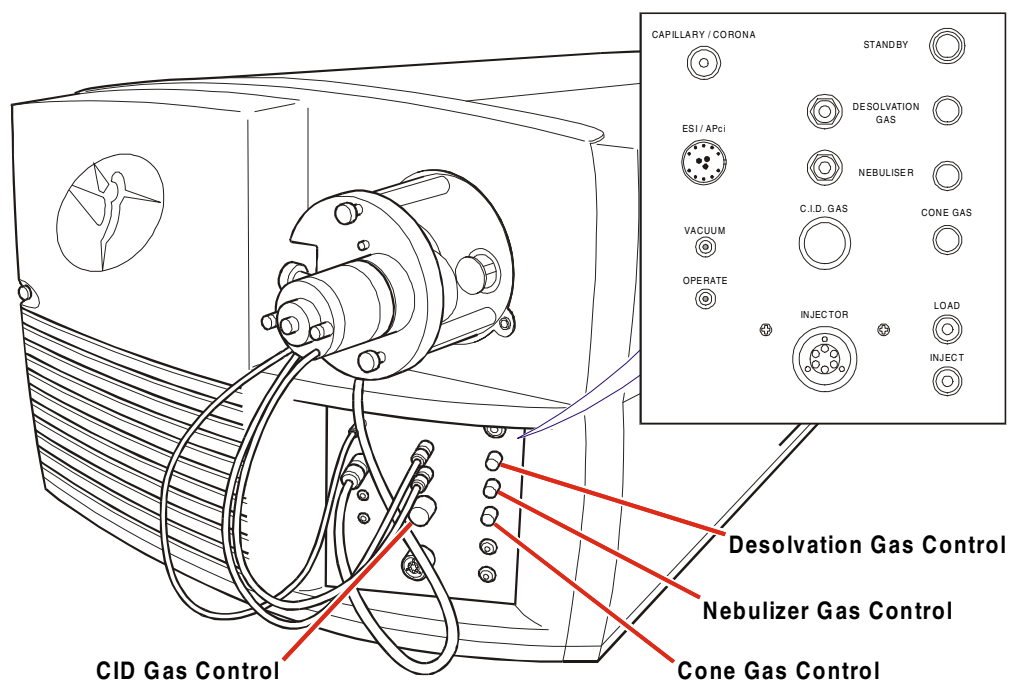

Figure 1-11 Front Panel Controls and Indicators

Status Display

The display on the front panel of the instrument consists of two 3-color light emitting diodes (LEDs).

The **Vacuum** LED display depends on the instrument vacuum status. The **Operate** LED display depends on both the vacuum status, and whether the **Operate** mode has been selected from the Data System.

The status of the instrument is indicated as follows:

Vacuum LED

State	Vacuum LED		State	Vacuum LED
Vented	No indication		Vacuum OK	Steady green
Pumping	Steady amber		Pump fault	Flashing red

Operate LED

State	Operate LED		State	Operate LED
Standby	No indication		Transient pressure trip	Steady amber
Operate	Steady green		RF trip	Flashing red

Flow Control Valves



Caution: When turning the supply off, take care not to over-tighten the **CID Gas** valve, otherwise it may be damaged.

The **Desolvation Gas**, **Cone Gas**, and **Nebuliser** needle valves are five-turn valves. The **CID Gas** valve is a fifteen-turn valve. The flow increases as the valve is turned counterclockwise.

Divert/Injection Valve

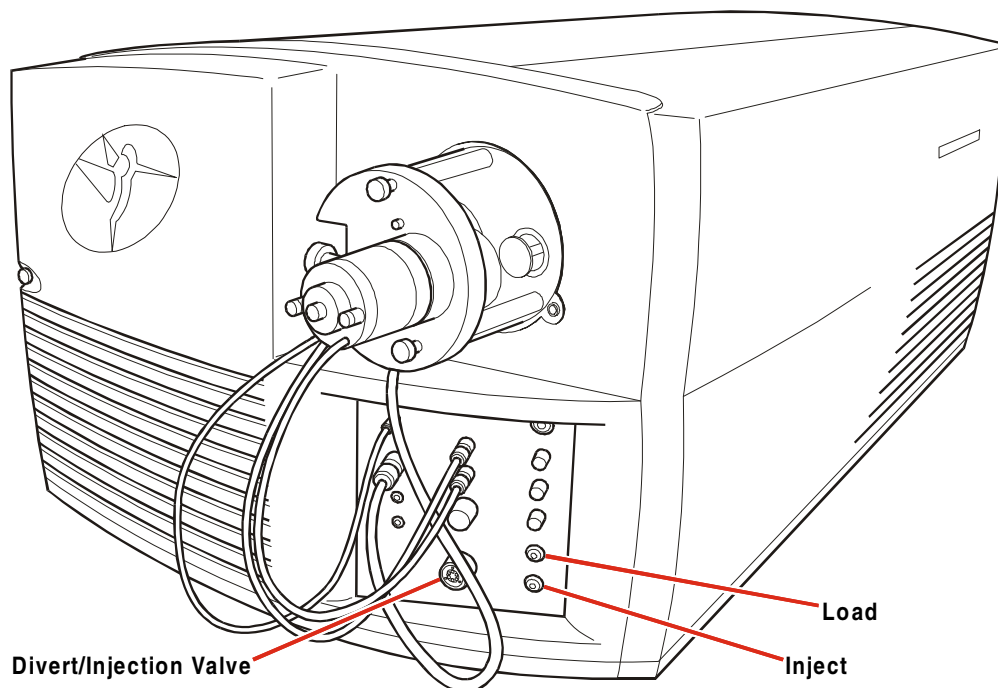

Figure 1-12 Divert/Injection Valve

The optional divert/injection valve may be used in several ways, depending on the plumbing arrangement:

- As an injection valve, with the needle port and sample loop fitted.
- As a divert valve, to switch the flow of solvent during a LC run.
- As a switching valve to switch, for example, between a LC system and a syringe pump containing calibrant.

This valve is pneumatically operated, using the instrument's nitrogen supply.

Note that the valve is connected such that the nitrogen supply is always connected to the valve, irrespective of the flow to the source and probe.

Control of the valve is primarily from the data system. The two switches marked **Load** and **Inject** enable the user to override control of the valve when making loop injections at the instrument.

1.10 Rear Panel Connections

Event Out

Four outputs, **Out 1** to **Out 4**, are provided to allow various peripherals to be connected to the instrument. Switches **S1** to **S4** allow each output to be set to be either a contact closure (upper position) or a voltage output (lower position).



Warning: In contact closure mode, do not apply a voltage greater than 48 V to the connections.



Caution: The maximum current passed through the contacts in either mode must not exceed 300 mA, otherwise the instrument may be damaged.

Out 1 and **Out 2**, when set to voltage output, each have an output of 5 V. The voltage output of both **Out 3** and **Out 4** is 24 V.

During a sample run, **Out 1** closes between acquisitions, and is used typically to enable an external device to inject the next sample. The three remaining outputs are reserved for future developments.

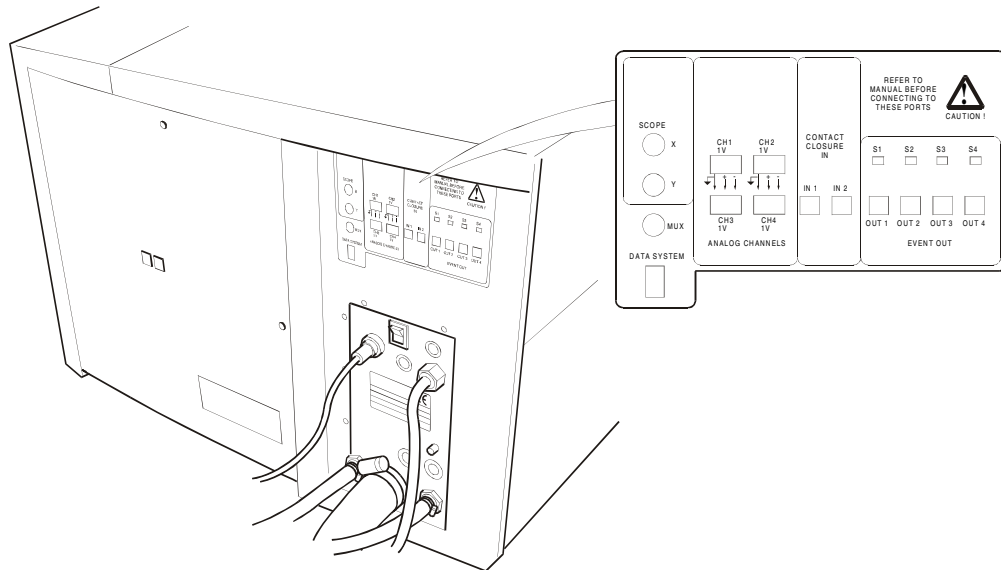

Figure 1-13 Event Out Connections

Contact Closure In

In 1 and **In 2** inputs are provided to allow external device to start sample acquisition once the device has performed its function (typically sample injection).

Analog Channels

Four analog channel inputs are available, for acquiring simultaneous data such as a UV detector output. The input differential voltage must not exceed 1 V, though full scale automatically adjusts from 1 mV to 1 V.

MUX

This 6-way connector connects the instrument to the MUX control base.

Data System

This RJ45 connector connects the instrument to the data system using the network cable supplied.

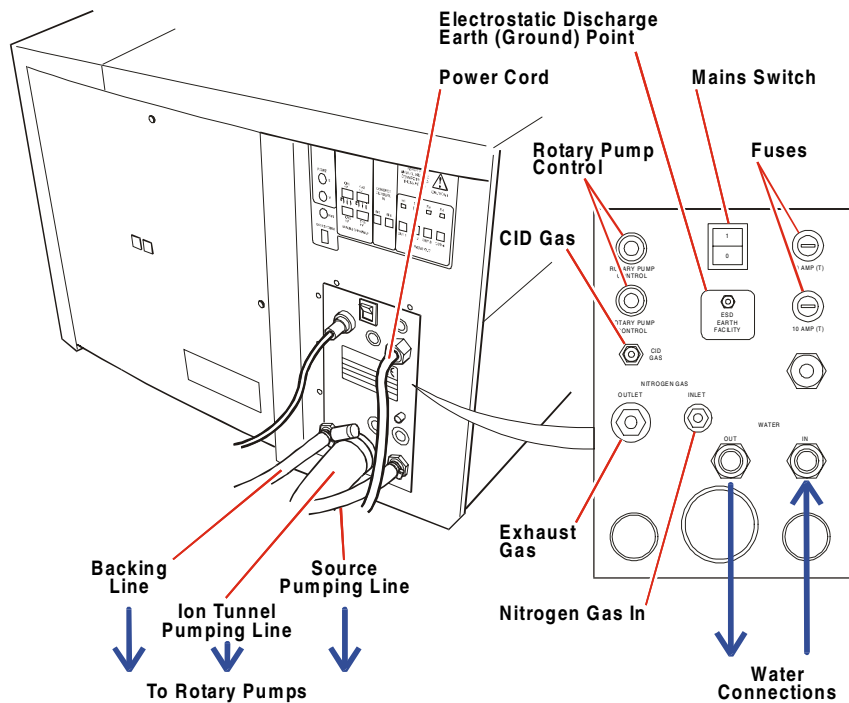

Figure 1-14 Rear Panel Connections

Water

Water is used to cool the turbomolecular pumps.

Nitrogen Gas In



Caution: Use only PTFE tubing or clean metal tubing to connect between the nitrogen supply and the instrument. The use of other types of plastic tubing results in chemical contamination of the source.

The nitrogen supply (100 psi, 7 bar) is connected to the **Nitrogen Gas In** push-in connector using 6 mm PTFE tubing. If necessary, this tubing can be connected to ¼ inch tubing using standard ¼ inch fittings.

Exhausts



Caution: Do not connect the two exhaust lines together as, in the event of an instrument failure, rotary pump exhaust could be admitted into the source chamber producing severe contamination.

The exhaust from the rotary pump should be vented to atmosphere outside the laboratory.

The gas exhaust, which also contains solvent vapors, should be vented via a separate fume hood, industrial vent, or cold trap.

The gas exhaust should be connected using 10 mm plastic tubing connected to the push-in fitting.

CID Gas

Argon is required as collision gas. See the *Hardware Specifications* section for details.

Power Cord



Warning: The instrument must be installed in such a manner that the user can easily access and isolate the power source.

The mains power cord should be wired to a suitable mains outlet using a standard plug. For plugs with an integral fuse, the fuse should be rated at 13 A.

Mains Switch

The mains switch switches mains power to the instrument.

Fuses

Refer to the *Maintenance and Fault Finding* section for details of rear panel fuses, and all other instrument fuses.

Rotary Pump Control

Mains power to the two rotary pumps is controlled by the data system using one of these two sockets. The other socket is connected to the solenoid valve situated in the oil return tube on the E1M18 pump.

ESD Earth Facility

A suitable wristband should be connected to this point when handling sensitive electronic components, to prevent damage by electrostatic discharge.

1.11 Internal Layout

Electronics

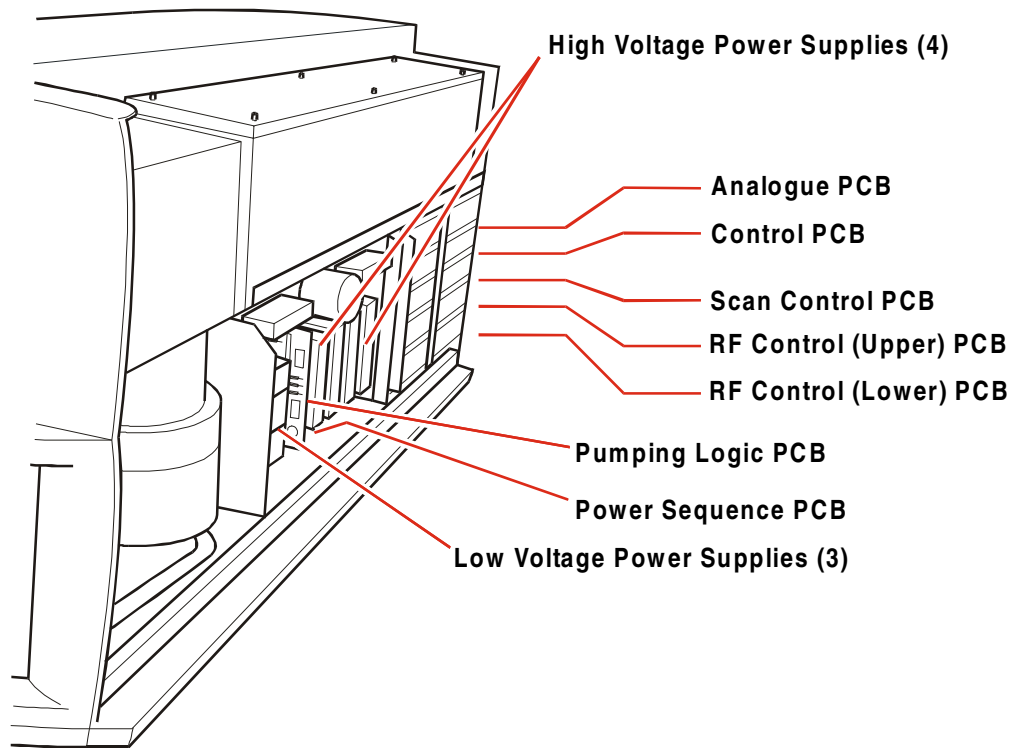

Figure 1-15 Internal Layout of Electronics

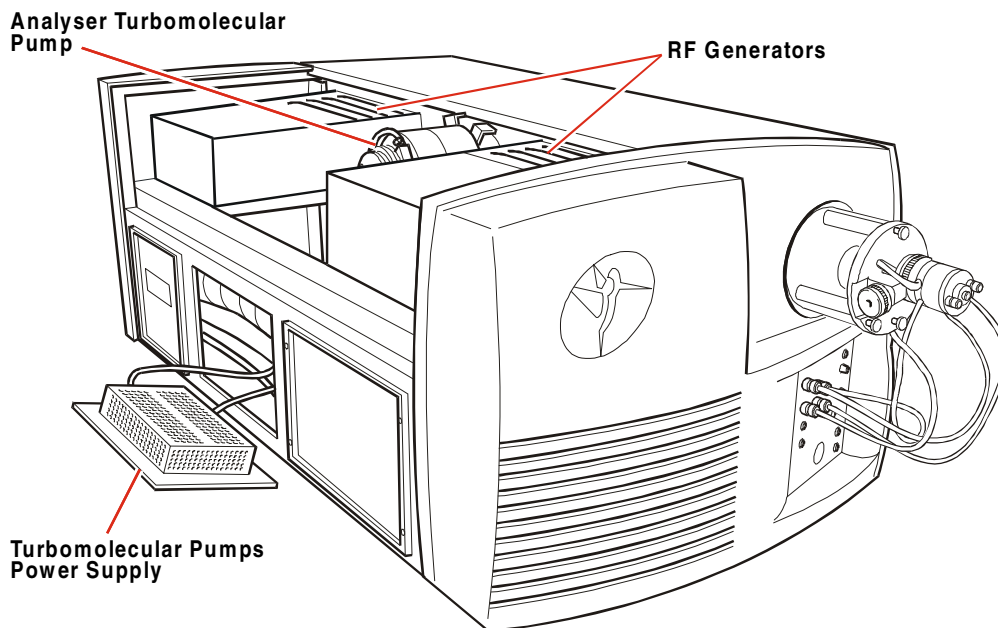

Figure 1-16 Main Electronics Modules

The main electronics modules of the system are:

- Three low voltage power supplies.
- Four high voltage power supplies, plugged into the back-plane below the analyzer housing.

These supply the detector system and the high voltages for the source and ElectroSpray probe.

- Two RF generators, bolted to the side of the analyzer housing.
- Pumping Logic Printed Circuit Board (PCB).

This controls the turbomolecular pumps, the pumping sequence, the gas valves and the solenoids. It also controls the phosphor and dynode voltages.

- Power Sequence PCB.

This PCB examines the vacuum, operate and interlock signals in order to control the switching of various supplies. Also on this PCB, is a module delivering the photomultiplier voltage.

- Analog PCB.

This PCB controls the source heater and focussing voltages.

- Control PCB.

This supplies various lens voltages to the source and first ion tunnel.

- Scan Control PCB.

This PCB produces control signals for mass, resolution, function energy, collision energy and pre-filter energy.

- RF Generator Control (Upper) PCB.

This controls the RF and d.c. voltages applied to the first quadrupole. It also supplies some of the collision cell voltages.

- RF Generator Control (Lower) PCB.

This controls the RF and d.c. voltages applied to the second quadrupole.

Mechanical Components

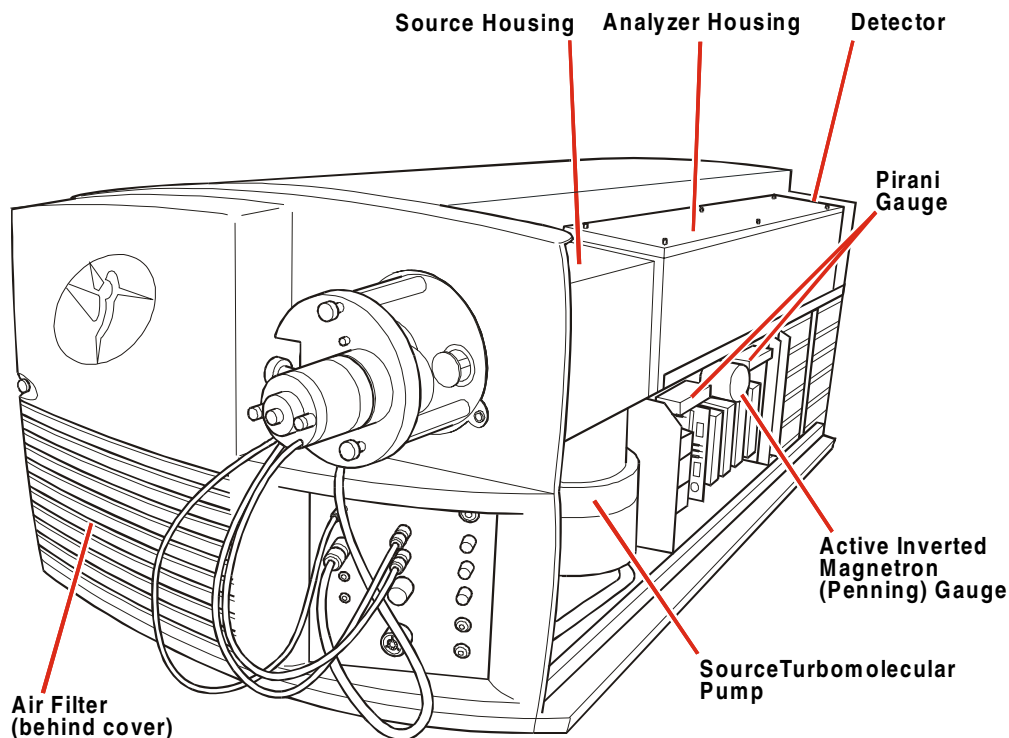

Figure 1-17 Main Internal Mechanical Components

The main internal mechanical components of the instrument are:

- The source housing, containing the ion tunnels.
The ion tunnels are sometimes referred to as the “RF lenses”.
- The analyzer housing, containing the two quadrupoles and the collision cell.
- The detector, attached to the rear of the analyzer housing.
- Two 250 l/s turbomolecular pumps, one pumping each of the above housings.
- The active inverted magnetron (Penning) gauge and the Pirani gauge, both clamped to the underside of the analyzer housing.
- The air filter, held in the louvered cover at the left side of the front of the instrument.

Chapter 2

Routine Procedures

2.1 Start Up Following a Complete Shutdown

2.1.1 Preparation

If the instrument has been unused for a lengthy period, proceed as follows:

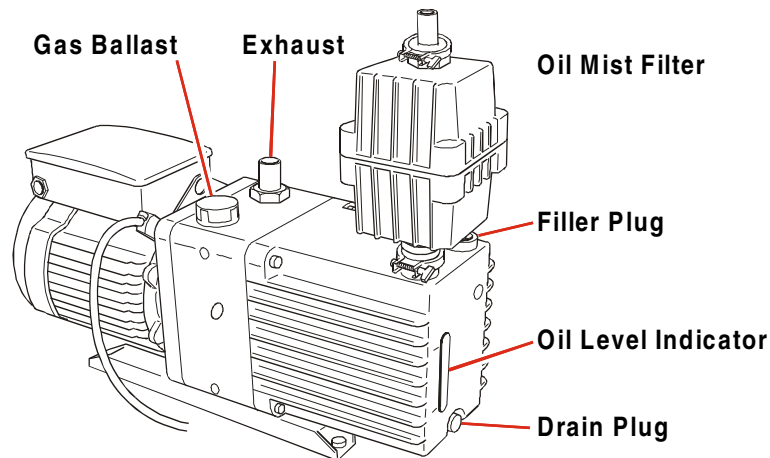

Figure 2-1 Edwards Rotary Pump

Check the level of oil in the rotary pump sight glass. Refill or replenish as necessary as described in the pump manufacturer’s literature.

Connect a supply of dry, high purity nitrogen to the connector on the service panel at the rear of the instrument. Adjust the outlet pressure to 7 bar (100 psi).

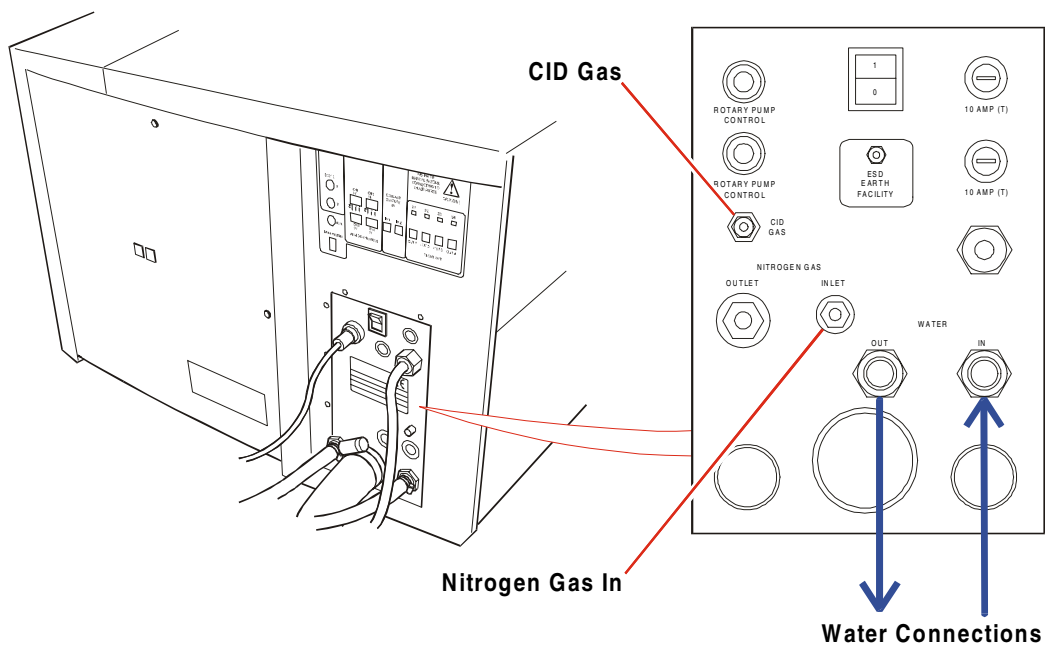

Figure 2-2 Gas/Water Connections

Connect a supply of argon to the **CID Gas** connector on the service panel at the rear of the instrument. Adjust the outlet pressure to approximately 350 mbar (5 psi).

Connect the water supply to the connections at the rear of the instrument.

Check that the rotary pump control box is connected to **Rotary Control** at the rear of the instrument, and to the rotary pumps. Check that the solenoid valve on the E1M18 rotary pump is connected to the other **Rotary Control** socket.

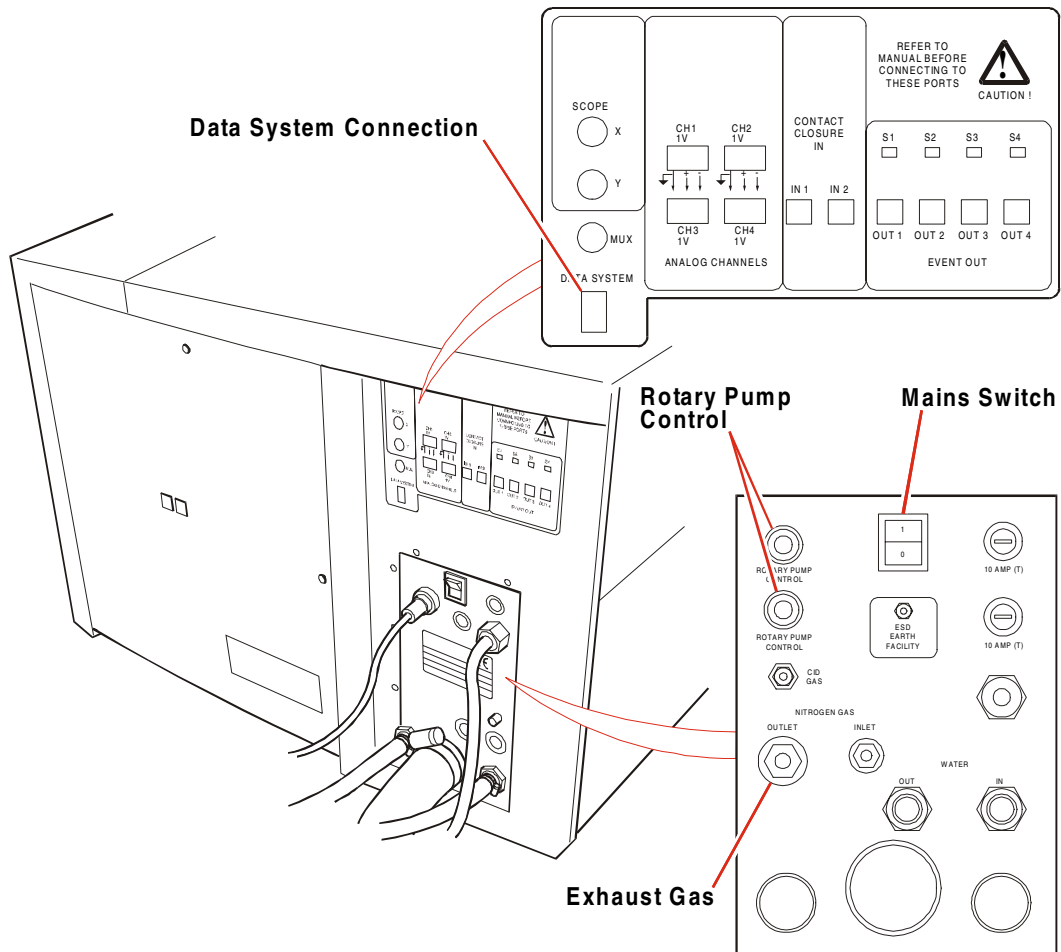

Figure 2-3 Rear Exhaust and Peripheral Connections

Check that the instrument, rotary pump control box, data system, and other peripheral devices (LC equipment, printer, etc.) are connected to suitable mains power supplies.

Check that the data system is connected to the mass spectrometer via the network cable.



Caution: Do not connect the two exhaust lines together. In the event of an instrument failure, rotary pump exhaust could be admitted into the source chamber, producing severe contamination.

Check that the rotary pump exhaust is connected to a suitable vent.

Check that the exhaust gas from the instrument is connected to a separate vent.

Switch on the mains to the mass spectrometer using the switch situated on the service panel at the rear of the instrument.

Switch on the data system.

As supplied, Windows NT is automatically activated following the startup sequence whenever the data system is switched on.

Windows NT and MassLynx NT can be configured to prevent unauthorized access. Consult the system administrator for any passwords that may be requested.

When the data system has booted up, double-click on the MassLynx icon,  , on the Windows desktop, to start MassLynx.

Open the Tune Page;

Select the **Instrument** Shortcut Bar **MS Tune** icon,  .

2.1.2 Pumping



Caution: To minimize wear to the lubricated components of the rotary pump, the manufacturers recommend that the pump is not started when the oil temperature is below 12 °C.

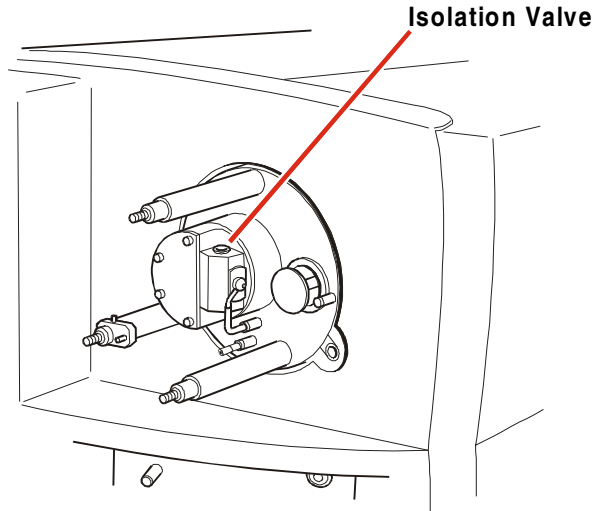

Figure 2-4 Source Isolation Valve

Pump down time may be decreased by closing the source isolation valve during pump down.

Select the Tune Page Menu Bar **Options, Pump** command.

The rotary pump and the turbomolecular pumps start simultaneously.

*The **Vacuum** LED on the front of the instrument shows amber as the system pumps down.*

When the system has reached operating vacuum, the LED changes to a steady green, indicating that the instrument is ready for use.



Caution: The instrument should not be vented while the E2M28 rotary pump is running under gas ballast. See the *Maintenance and Fault Finding* section for more information.

Ensure that the gas ballast valve on the E1M18 rotary pump is open.

The E1M18 rotary pump is operated with its gas ballast valve open at all times.

If the E2M28 rotary pump oil has been changed or replenished, open the gas ballast valve on this pump. See the pump manufacturer's literature for details.

Rotary pumps are usually noticeably louder when running under gas ballast.

If opened, close the gas ballast valve on the E2M28 rotary pump when the pump has run under gas ballast for 30 minutes.

2.1.3 Measuring the Analyzer Pressure



Caution: To maximize the life of the Penning gauge, it is recommended that the gauge is switched on only when the pressure needs to be monitored. Leaving the analyzer pressure displayed for long periods necessitates frequent (every 2 to 4 months) cleaning of the Penning gauge.

The analyzer pressure may be monitored via the active inverted magnetron (Penning) gauge.

This gauge operates by generating a high voltage discharge within the vacuum chamber. The magnitude of the discharge current is then measured and used to calculate the analyzer pressure. An undesirable characteristic of this type of gauge is the slow build up of sputtered material in the discharge region, eventually leading to failure of the gauge.

To switch on the gauge:

Select the Tune Page Tool Bar  button, or select the Menu Bar **Options, Vacuum Monitor** command; there is a delay of 10 seconds before the Tune Page Pressure Display is invoked.

To switch off the gauge:

Select the Tune Page Tool Bar  button, or select the Menu Bar **Options, Peak Editor** command; the Tune Page Peak Editor Display is invoked.

The analyzer pressure is not recorded in the experimental record file unless the pressure window is displayed prior to starting the acquisition. However, the gas cell pressure (monitored by the gas cell Pirani gauge) is always recorded.

2.1.4 Using the Instrument

Quattro Ultima Pt is now almost ready to use. To complete the startup procedure and prepare for running samples, follow the instructions in the *Start Up Following Overnight Shutdown* section.

2.2 Start Up Following Overnight Shutdown

The instrument will have been left in standby mode under vacuum.

It is recommended that the data system is left on overnight. However, if the data system has been switched off, switch it on as described in the *Start Up Following a Complete Shutdown Following a Complete Shutdown, Preparation* section.

*The display on the front of the instrument displays a steady green **Vacuum** LED indicating that the instrument is ready for use.*

2.2.1 Preparation for ElectroSpray Operation

The following figure shows the instrument configured for ElectroSpray operation; see the Preparation for Ion Sabre APcI Operation section for a figure showing the instrument configured for Ion Sabre APcI operation.

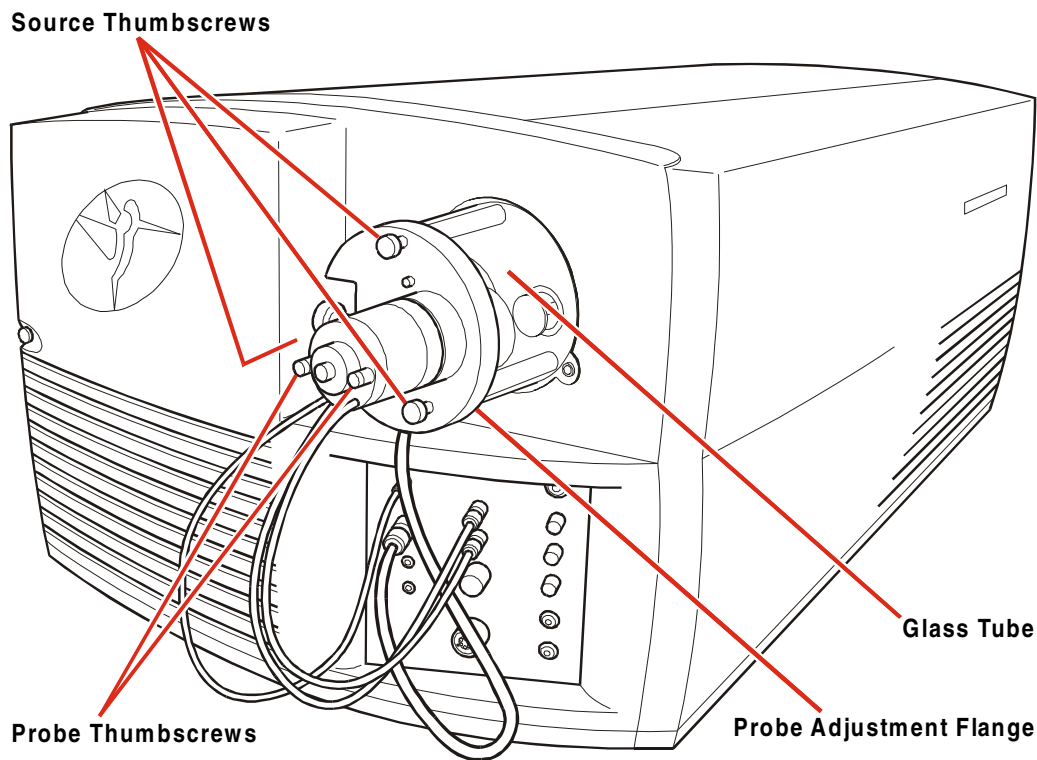

Figure 2-5 Preparation for ElectroSpray Operation

If the Ion Sabre APcI probe is fitted, proceed as follows:

Disconnect the gas and electrical connections from the front panel.

Unscrew the probe thumbscrews (2-off).

Remove the probe.



Warning: Operating the source without the source enclosure results in solvent vapor escape and the exposure of hot surfaces and high voltages. Allow the source enclosure to cool after operation at high flow rates before removal.



Warning: The ion source block can be heated to temperatures of 150 °C, and is maintained at the set temperature when the source enclosure is removed. Touching the ion block when hot may cause burns to the operator.

Unscrew the source thumbscrews (3-off).

Remove the probe adjustment flange.

Remove the outer (plastic) and inner (glass) tubes.

Disconnect the APcI cable from the high voltage socket at the bottom right corner of the source flange.

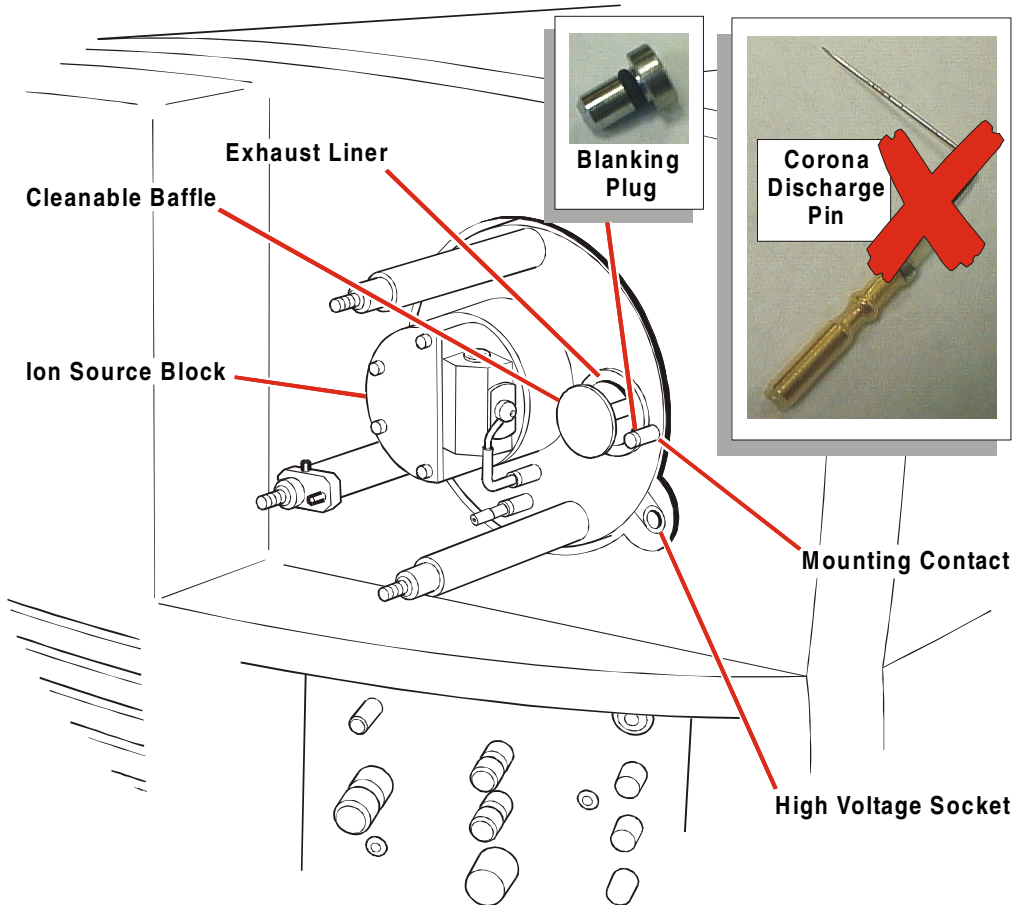

Figure 2-6 Replacing the Corona Discharge Pin For ESI

Remove the corona discharge pin from its mounting contact.

Fit the blanking plug in the corona discharge pin mounting contact.

Fit the ESI source enclosure (consisting of the glass tube and the probe adjustment flange).

Fit and tighten the source thumbscrews (3-off).

Connect the source's gas line to the front panel **Desolvation Gas** connection. Tighten the nut to ensure a good seal.

Connect the probe adjustment flange lead to the front panel **ESI/APCI** socket.

Fit the probe to the probe adjustment flange.

Fit and tighten the probe thumbscrews (2-off).

Connect the ElectroSpray probe's gas line to the front panel **Nebuliser** connection.

Connect the liquid flow of a LC system, or syringe pump, to the probe.

Connect the probe lead into the front panel **Capillary/Corona** socket.

On the PC, invoke the Tune Page by selecting the MassLynx Instrument Shortcut

Bar MS Tune icon,  MS Tune .

The left-hand tab in the Tune Page indicates the current ionization mode.

If necessary, change the ionization mode using the Menu Bar **Ion Mode** command.



Warning: Operating the source without the source enclosure in position results in solvent vapor escape and the exposure of hot surfaces and high voltages.

Set the **Source** frame **Source Temp** (°C) to 100 °C and **Desolvation Temp** (°C) to 20 °C.

2.2.2 Preparation for Ion Sabre APCl Operation

The following figure shows the instrument configured for Ion Sabre operation; see the Preparation for ElectroSpray Operation section for a figure showing the instrument configured for ElectroSpray operation.

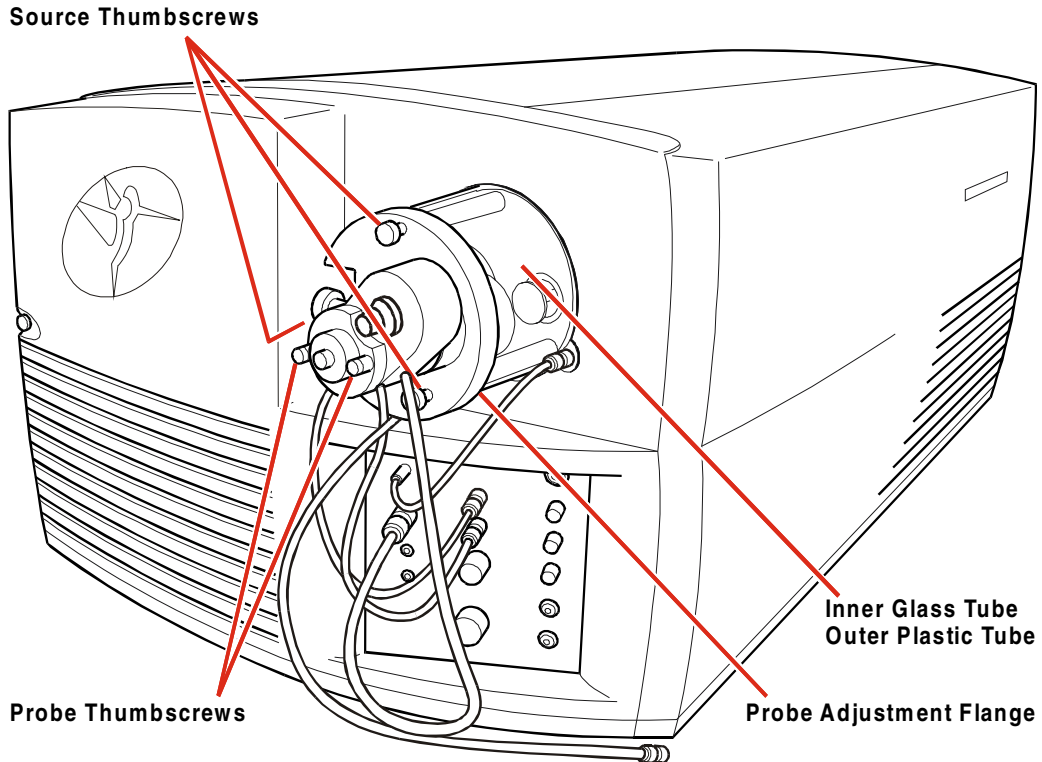

Figure 2-7 Preparation for APCI

If the ElectroSpray probe is fitted, proceed as follows:

Disconnect the gas and electrical connections from the front panel.

Unscrew the probe thumbscrews (2-off).

Remove the probe.



Warning: Operating the source without the source enclosure results in solvent vapor escape and the exposure of hot surfaces and high voltages. Allow the glass source enclosure to cool after operation at high flow rates before removal.



Warning: The ion source block can be heated to temperatures of 150 °C, and is maintained at the set temperature when the source enclosure is removed. Touching the ion block when hot may cause burns to the operator.

Unscrew the source thumbscrews (3-off).

Remove the probe adjustment flange.

Remove the glass tube.

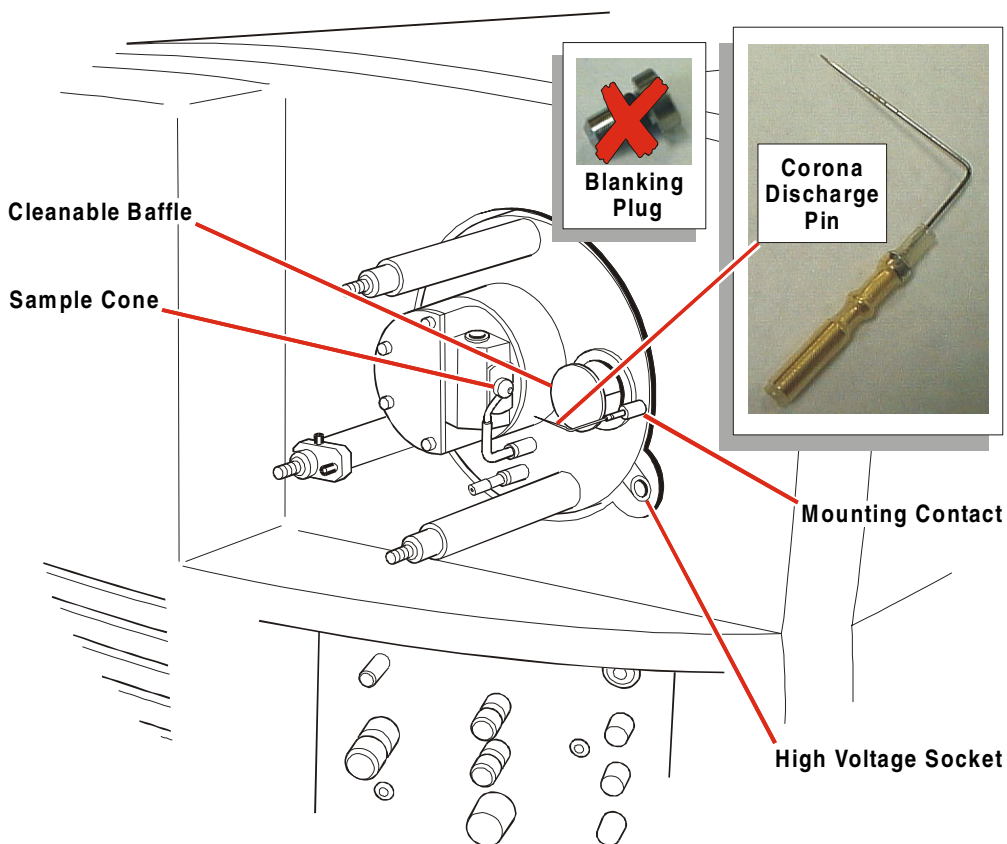

Figure 2-8 Inserting Corona Discharge Pin for APCI

Remove the blanking plug from corona discharge pin mounting contact.

Fit the corona discharge pin in its mounting contact; ensure that the pin tip is in-line with the tip of the sample cone.

Connect the APcI high voltage cable between the high voltage socket (at the bottom right corner of the source flange) and the front panel **Capillary/Corona** socket.

Fit the Ion Sabre APcI source enclosure (consisting of the outer plastic tube, the inner glass tube, and the probe adjustment flange).

Fit and tighten the source thumbscrews (3-off).

Connect the source's gas line to the front panel **Desolvation Gas** connection. Tighten the nut to ensure a good seal.

Fit the probe to the probe adjustment flange.

Fit and tighten the probe thumbscrews (2-off).

Connect the Ion Sabre APcI probe lead to the front panel **ESI/APcI** socket.

Connect the Ion Sabre APcI probe gas line to the front panel **Nebuliser** connection.

Connect the liquid flow of a LC system, or syringe pump, to the probe.

On the PC, invoke the Tune Page by selecting the MassLynx **Instrument**

Shortcut Bar **MS Tune** icon,  **MS Tune**.

The left-hand tab in the Tune Page indicates the current ionization mode.

If necessary, change the ionization mode using the Menu Bar **Ion Mode** command.



Warning: Operating the source without the source enclosure in position results in solvent vapor escape, and the exposure of hot surfaces and high voltages.

Set the **Source** frame **Source Temp** (°C) parameter to 150 °C and **APCI Probe Temp** (°C) to 20 °C.

The liquid flow should not be started until the gas flow and the probe heater are switched on with the probe inserted.

2.2.3 Operate

Select the MassLynx Tune Page  button.

The instrument enters the operate mode only if the probe adjustment flange is in place and a probe is inserted.

Select the Tool Bar  button, or select the Menu Bar **Gas, Gas** command to turn on the source and probe gases.

Using the valves on the instrument front panel, set **Desolvation Gas** to a flow of 150 l/h and adjust **Nebuliser** to the maximum value. Additionally, for APCI operation, use the dial on the probe body to set the support gas to 1.0.

The system is now ready for operation. To obtain an ion beam refer to *Obtaining an Ion Beam* in either the *ElectroSpray* or the *Atmospheric Pressure Chemical Ionization* sections.

2.3 Automatic Pumping and Vacuum Protection

2.3.1 Overview

The instrument is protected against vacuum system faults due to:

- Malfunction of the vacuum pumps.
- Excessive pressure.
- Excessive temperature.

The pump-down sequence is fully automated, a command from the data system switching on the rotary pump and turbomolecular pumps simultaneously.

2.3.2 Protection

Transient Pressure Trip

If the vacuum gauge detects a pressure surge above the factory set trip level of 10^{-3} mbar, and if the instrument is in the operate mode, the following events occur:

The critical source, analyzer and detector voltages are switched off.

The **Operate** LED shows a steady amber.

The **Vacuum** LED shows a steady amber.

Acquisition continues, although no mass spectral data are recorded.

When the pressure recovers, the voltages are restored and the **Vacuum** and **Operate** LEDs are steady green.

Any further deterioration of the system vacuum results in a pump fault and the system is shut down.

Pump Fault

A pump fault causes the following to occur:

The turbomolecular pumps stop pumping.

On the display, the **Vacuum** LED flashes red.

The **Operate** LED is extinguished.

As the turbomolecular pumps slow down, the vent valve opens, the rotary pump switches off and the system is vented.

The pumps do not switch on again unless requested to do so.

A pump fault can occur as a result of:

- Overheating of the turbomolecular pumps.

If the water-cooling fails, then the turbomolecular pumps switch off when their temperature becomes too high.

- Vacuum leak.

Refer to the Maintenance and Fault Finding section.

- Malfunction of the turbomolecular pumps.
Refer to the pump manufacturer's manuals.
- Malfunction of the rotary pump.
Refer to the pump manufacturer's manuals.

Power Failure

In the event of an unexpected power failure, proceed as follows:

Switch OFF the power to the instrument at the wall mounted isolation switch.

When power is restored, follow the start up procedure described in the *Start Up Following a Complete Shutdown* section.

2.4 Tuning

Information concerning the tuning of Quattro Ultima Pt is provided in the *Tuning* section. Refer also to the *ElectroSpray*, *NanoFlow ElectroSpray*, and *Atmospheric Pressure Chemical Ionization* sections for tuning information specific to those techniques.

2.5 Calibration

Information concerning the calibration of Quattro Ultima Pt is provided in the *Mass Calibration* section.

2.6 Data Acquisition

Sample data acquisition is comprehensively described in the *Data Acquisition* section.

2.7 Data Processing

Refer to the *MassLynx NT User's Guide* for details of sample data processing.

2.8 Setting-Up for MS-MS Operation

The following notes provide a worked example for the acquisition of daughter ion data. The experiment is performed in the ESI positive mode using reserpine as a model analyte. Reserpine, admitted by constant infusion at a concentration of 50 pg/ μ l, provides a stable and persistent source of ions for instrument tuning in both the MS and MS-MS modes of operation.

The basic sequence of events is as follows:

- Tuning MS1.
- Tuning MS2.
- Parent ion selection.
- Fragmentation.

Detailed information on these processes can be found in the *Tuning* and *Data Acquisition* sections.

2.8.3 Parent Ion Selection

For maximum sensitivity in daughter ion analysis the center of the parent ion selected by MS1 must be accurately found. The nominal mass of the parent is first determined (if unknown) by viewing it in MS mode:

Set up a single box display on the Tune Page and set **Function** to **MS Scan**. Observe the candidate parent ion in the display and determine its nominal mass.

In this example, the reserpine ion at m/z 609 is used as a model parent.

The accurate top of the parent ion can be found experimentally by performing a “daughter ion scan” over a restricted mass range in the absence of collision gas.

On the Tune Page, set **Function** for peak 2 to **Daughter Scan**.

Place the mouse cursor on the **Set** mass for peak 2 and type in the nominal mass of the parent ion selected by MS1, in this case 609.

Vary the **Set** value between 608.5 and 609.5 while optimizing the intensity of the non-fragmented parent ion in the tune display.

The **Set** mass giving maximum intensity is used for future MS-MS experiments.

2.8.4 Fragmentation

The ion tunnel collision cell uses an axial voltage gradient to reduce ion transit time. The software can automatically control this voltage to an optimum value in each operation mode. It is recommended that this mode is used. It can, however, be over-ridden by selecting the Tune Page Menu Bar **Options, Manual Collision Gradient** command; this enables the Tune Page **Collision Gradient** control.

Set up a wide range daughter ion scan by adjusting the **Mass** and **Span** parameters for peak 2.

At this point, with the collision gas off, a few daughter ions of low intensity may be visible. These are the products of unimolecular dissociations.

Argon (99.9% pure) should be used as the collision gas.

Select the Menu Bar **Gas, Collision Gas** command.

Adjust the **CID Gas** valve, on the instrument front panel, to admit sufficient gas to attenuate the parent ion peak by about 50%.

On the Tune Page **Analyzer** tab, adjust the **Entrance, Collision, and Exit** parameters to produce the desired degree of fragmentation. (These parameters are interactive in MS-MS operation.)

In daughter ion analysis maximum transmission (sensitivity) can be achieved by the following adjustments:

- Optimizing the **Collision** parameter.
- Optimizing the **Exit** parameter.
- Optimizing the **Entrance** parameter.
- Optimizing the collision gas pressure using the **CID Gas** valve.

Additionally, transmission can be improved at the expense of specificity by reducing the **HM Resolution 1** parameter and increasing the **Ion Energy 1** parameter on the **Analyzer** tab. In most cases, where chemical interference with the parent ion is not acute, the loss of specificity is negligible.

2.9 Shutdown Procedures

2.9.1 Emergency Shutdown

In order to shutdown the instrument in an emergency, proceed as follows:

Switch off the power at the wall mounted isolation switch(es), if fitted. If not, switch off the power at the rear of the instrument and switch off all peripherals.

Isolate any LC systems to prevent solvent flowing into the source.

A loss of data is likely.

2.9.2 Overnight Shutdown

When the instrument is to be left unattended for any length of time, for example overnight or at weekends, proceed as follows:

Switch off the LC pumps.

Invoke the Tune Page by selecting the MassLynx **Instrument** Shortcut Bar

MS Tune icon,  MS Tune .

Select the  button.

The adjacent indicator changes from green to red, indicating that the instrument is no longer in the operate mode.

Undo the finger-tight connector on the probe to release the tubing leading from the LC system.

Before disconnecting the probe, it is good practice to temporarily remove the probe and flush it of any salts, buffers, or acids.



Caution: Leaving the APcI probe hot with no gas or liquid flow shortens the lifetime of the probe heater.

If APcI is being used, switch off the probe heater or reduce it to ambient temperature.

Select the Tune Page Menu Bar **Gas**, **Gas** command to turn off the nitrogen gas supply.

If the instrument is not to be used for a long period of time:

Set the Tune Page **Source** frame **Source Temp** (°C) parameter to 60 °C.

2.9.3 Complete Shutdown

If the instrument is to be left unattended for extended periods, proceed as follows:

Switch off the LC pumps.

Invoke the Tune Page by selecting the MassLynx **Instrument** Shortcut Bar

MS Tune icon,  MS Tune .

Select the  button.

The adjacent indicator changes from green to red, indicating that the instrument is no longer in the operate mode.

Undo the finger-tight connector on the probe to release the tubing leading from the LC system.

Before disconnecting the probe, it is good practice to temporarily remove the probe and flush it of any salts, buffers or acids.



Caution: Leaving the APcI probe hot with no gas or liquid flow shortens the lifetime of the probe heater.

If APcI is being used, switch off the probe heater or reduce it to ambient temperature.

Select the **Tune Page** Menu Bar **Gas, Gas** command to turn off the supply of nitrogen gas.

Select the Tune Page Menu Bar **Options, Vent** command.

The rotary pump and the turbomolecular pumps switch off. When the turbomolecular pumps have run down to half of their normal operating speed, the vent valve opens and the instrument is vented to atmosphere.

Exit MassLynx.

Shutdown the computer.

Switch off all peripherals.

Switch off the power to the instrument using the switch on the rear panel of the instrument.

Switch off power at the wall mounted isolation switches.

If the instrument is to be switched off for more than one week:

Drain the oil from the rotary pump according to the manufacturer's instructions.

2.10 Automatic Startup and Shutdown - The Shutdown Editor

2.10.1 General

MassLynx has automatic startup and shutdown files (also known as task files) that are run when the **Instrument** Shortcut Bar **Startup** or **Shutdown** icons are selected.

The files are stored in the C:\Masslynx\Shutdown directory; they are ShutDownxxx.acl and StartUpxxx.acl, where xxx refers to the instrument configuration.

The **Shutdown** Editor allows the automatic startup and shutdown procedures to be modified, or new procedures to be created.

The **Shutdown** Editor is invoked by selecting the MassLynx **Instrument** Shortcut Bar **Edit Shutdown or Startup** icon. It has a Menu Bar, Tool Bar, **Shutdown** page and **Auto Control Tasks** page.

2.10.2 The Shutdown Editor Menu Bar

The File Menu

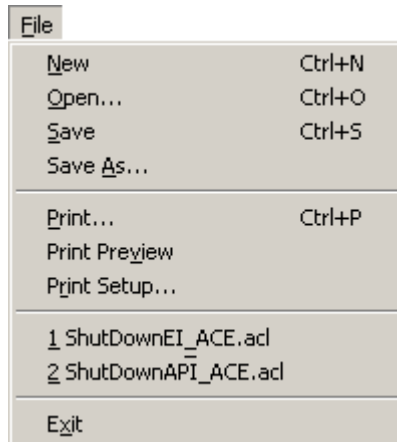

Figure 2-9 File Menu

New	Creates a new task file.
Open	Opens an existing task file, using the standard Windows Open dialog.
Save	Saves the current task file; the standard Windows Save As dialog is invoked if the file is a new file.
Save As	Invokes the standard Windows Save As dialog to save the current task file to a new file name.
Print	Invokes the standard Windows Print dialog to print out tasks in the current task file.
Print Preview	Allows the printout to be previewed.
Print Setup	Allows the printer setup to be configured.
File list	Lists the most recently accessed startup and shutdown files; click on a file to open it.
Exit	Closes the Shutdown Editor.

The Edit Menu

The **Edit** menu is not enabled at present.

The View Menu

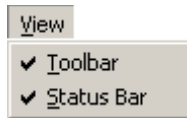

Figure 2-10 View Menu

Tool Bar	Toggles the Shutdown Editor Tool Bar on and off.
Status Bar	Toggles the Shutdown Editor Status Bar on and off.

The Control List Menu

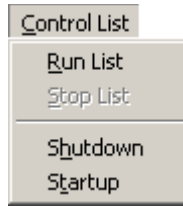

Figure 2-11 Control List Menu

2

Run List	Runs the current task list.
Stop List	Stops the currently running task list.
Shutdown	Runs the currently set shutdown task file.
Startup	Runs the currently set startup task file.

The Shutdown Log Menu

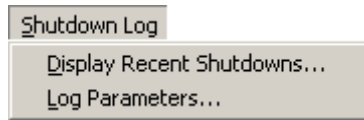

Figure 2-12 Shutdown Log Menu

Display Recent Shutdowns	Invokes the Shutdown/Startup Log dialog. This displays details of recent shutdowns and startups attempted by MassLynx.
---------------------------------	---

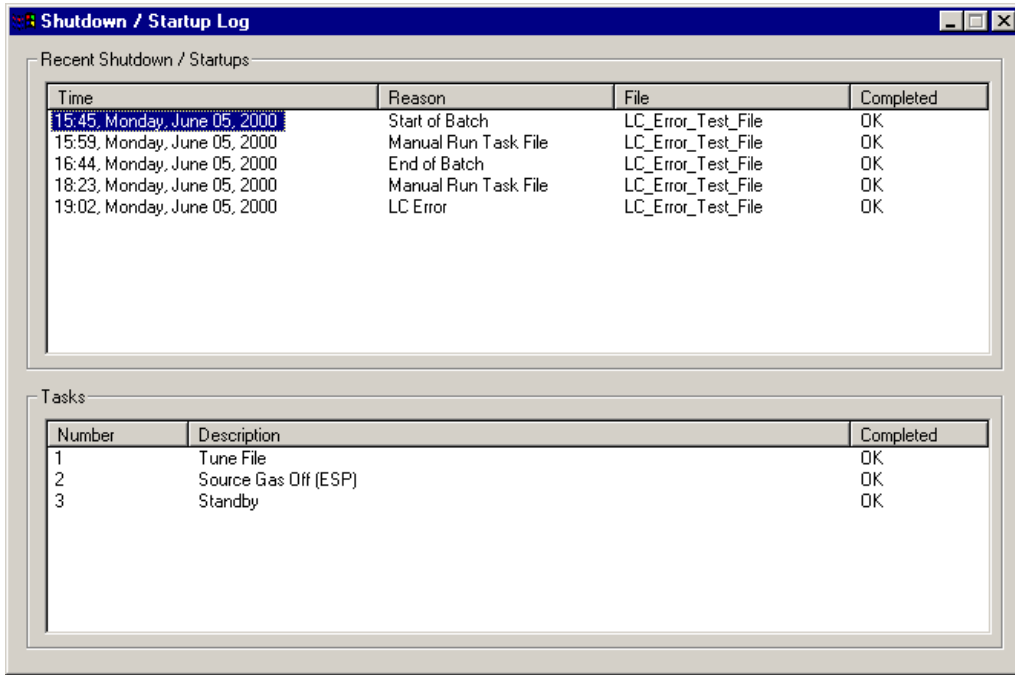

Figure 2-13 Shutdown/Startup Log Window

2

Log Parameters	Invokes the Shutdown Log Parameters dialog. This allows the User to select the number of entries to be saved for display in the Shutdown / Startup Log dialog; enter the required number in the Number of Shutdowns or Startups to save text box.
-----------------------	--

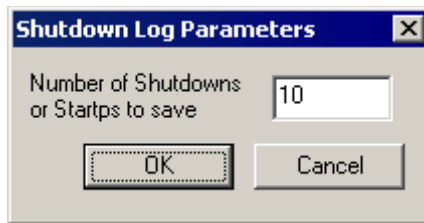
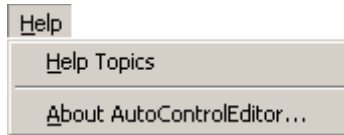

Figure 2-14 Shutdown Log Parameters







The Shutdown Help Menu



Help Topics	Invokes the Shutdown Help facility.
About AutoControlEditor	Invokes the About Shutdown window which provides information about the Shutdown Editor, including the version number.

2

2.10.3 The Shutdown Editor Tool Bar

Tool Bar Button	Menu Equivalent	Purpose
	File, New	Creates a new task file.
	File, Open	Opens an existing task file, using the standard Windows Open dialog.
	File, Save or File, Save As	Saves a task file; the standard Windows Save As dialog is invoked if the file is a new file.
	File, Print	Prints the tasks in the current task file.
	Control List, Run List	Runs the current task list.
	Control List, Stop List	Stops the currently running task list.
	Help, Help Topics	Invokes the Shutdown Help facility.

2.10.4 The Shutdown Editor Shutdown Page

The **Shutdown** Editor **Shutdown** page is used to configure the initiation of automatic startups and shutdowns.

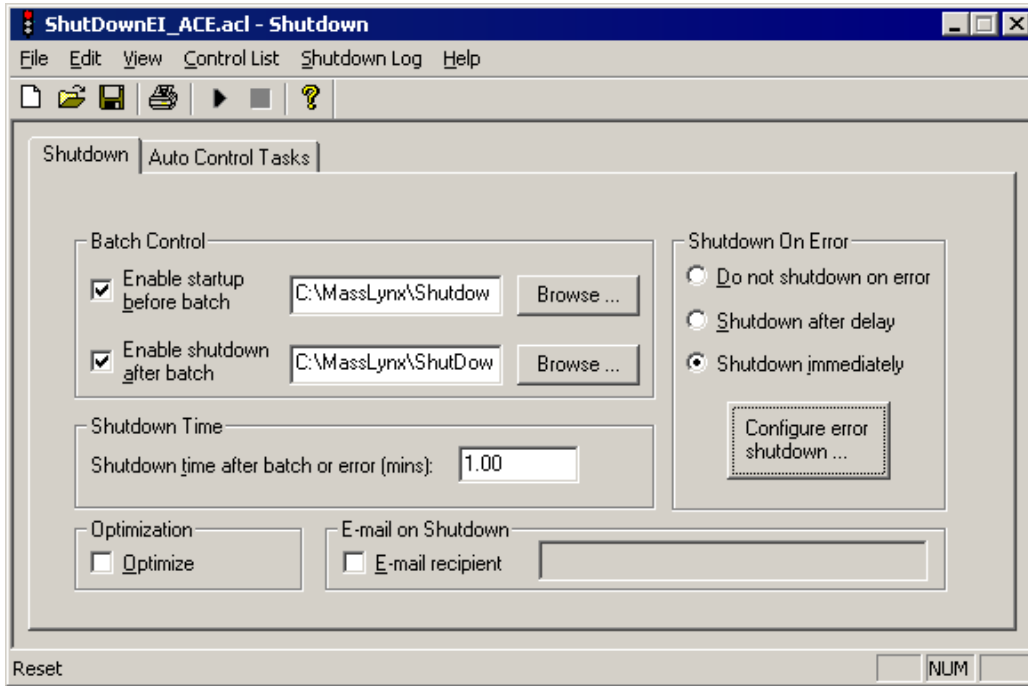

Figure 2-15 Shutdown Editor Shutdown Page

2

Batch Control Frame	
Enable startup before batch	Runs the task file detailed in the adjacent text box when a sample list is submitted. The task file can be selected using the Browse button.
Enable shutdown after batch	Runs the task file detailed in the adjacent text box after a batch of samples has been completed. The task file can be selected using the Browse button.

Shutdown Time Frame	
Shutdown time after batch or error (mins)	The delay, in minutes, between the batch finishing, or an error occurring, and the shutdown procedure starting.

Optimization Time Frame	
Optimize	<p>When selected, tasks that are already in the required state will not be run during the shutdown procedure. Optimize also by-passes any pre- and post-task delay for tasks not run.</p> <p>Optimize works for LC Pump On, LC Pump Off, UV Lamp On, UV Lamp Off, Standby, Operate, Set ESI Gas On, Set ESI Gas Off, Set Collision Gas On, Set Collision Gas Off.</p>

E-mail on Shutdown Frame	
E-mail recipient	In the event of a shutdown, automatically sends an e-mail message to the address entered in the adjacent text box.

Shutdown On Error Frame	
Do not shutdown on error	The system will not shutdown when an error is detected.
Shutdown after delay	When an error is detected, the system shutdown file will run after the time defined in the Shutdown Time Frame Shutdown time after batch or error (mins) text box.
Shutdown immediately	The system shutdown file will run immediately when an error is detected.
Configure error shutdown	This button is enabled when the either the Shutdown after delay or Shutdown immediately option is selected. The button invokes the Shutdown On Error Configuration dialog; which allows the types of detected error to be selected.

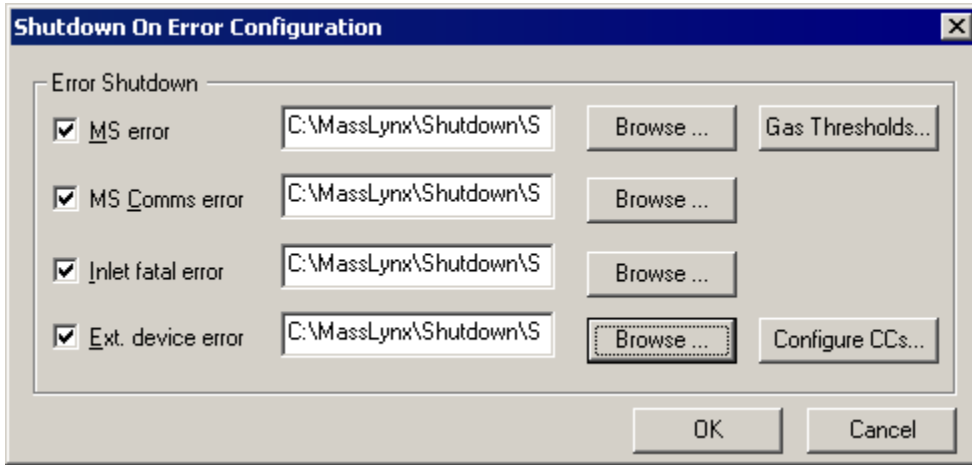

Figure 2-16 Shutdown Error Configuration

Error Shutdown Frame	
The options in this frame are used to select whether a detected error will enable the task file detailed in the adjacent text box. The Browse button can be used to select this file.	
MS error	Enables/disables running a task file when an MS error occurs.
Gas Thresholds	<p>Invokes the Gas Threshold dialog; an MS error is flagged if the source gas flow rate falls below the value entered in the Low Threshold... (L/Hr) text box.</p> <p><i>Note: The Gas Thresholds button is only available when the MS error option is selected.</i></p>

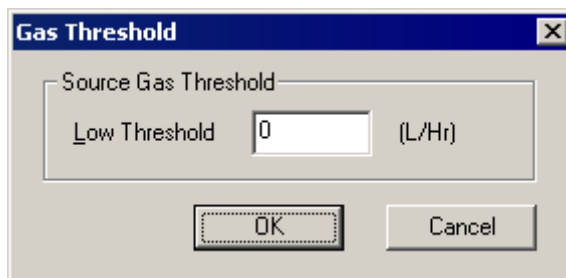

Figure 2-17 Gas Threshold Configuration

2

MS Comms error	Detects an error in the mass spectrometer communications link.
Inlet fatal error	Detects an inlet error.
Ext. device error	Detects an external device error; this can be configured using the Configure CCs button.
Configure CCs	<p>Invokes the Configure Event In dialog. This is used to configure the Contact Closure In In 1 and In 2 inputs (Event In contact closures). These are used to allow an external device to start sample acquisition, see the <i>Instrument Description, Contact Closure In</i> section).</p> <p>Note: The Configure CCs button is only available when the Ext. Device error option is selected.</p>

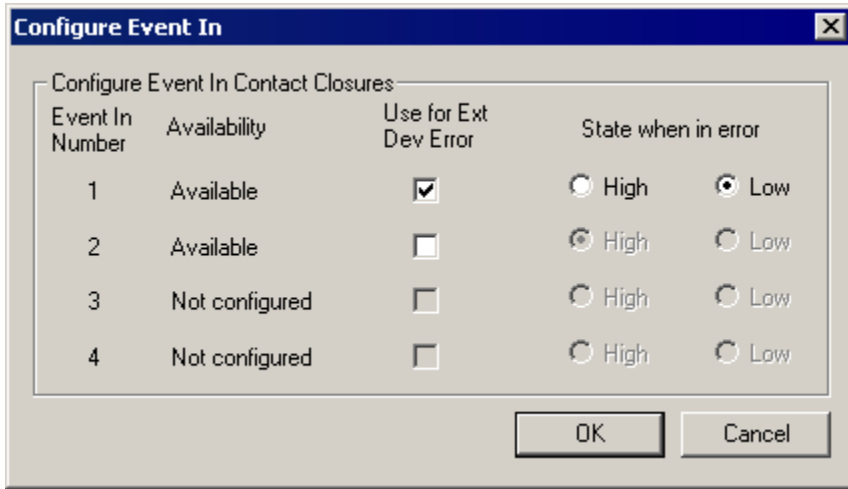

Figure 2-18 Event In Configuration

Only contact closures not used to signal the completion of an injection, or not used by MUX systems are enabled. Each of the available contact closures has the following controls:

Event In Number	Relates to the Event In number on the rear of the MS.
Availability	This can either be Used By Inlet, Available, Used by MUX, or Not Configured . The controls are only enabled if the contact closure is Available .
Use For Ext. Dev. Error	Enables/disables the use of this contact closure to signal an error in an external device.
State When in Error	Determines what state the contact closure will be in when an error is present in an external device.

2.10.5 The Shutdown Editor Auto Control Tasks Page

The **Shutdown Editor Auto Control** page is used to define the tasks to be run under defined conditions. Individual tasks can be selected and configured using the options on the left-hand side of the page; these can be added to the task list on the right-hand side of the page. These tasks can be saved to, and opened from, file using the **Shutdown Editor Menu Bar File** commands.

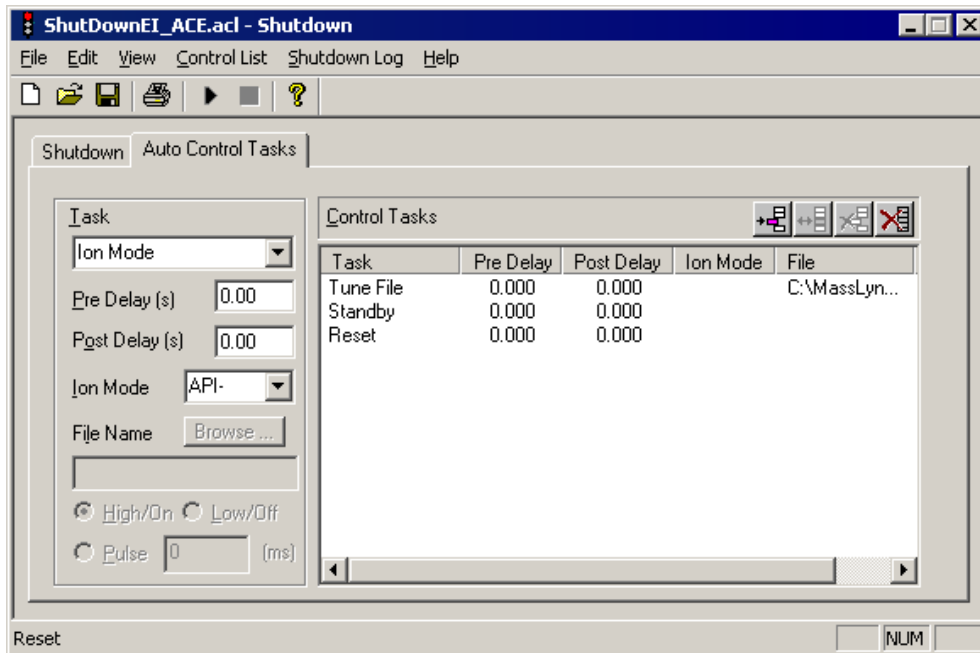





Figure 2-19 Shutdown Editor Auto Control Tasks

Task:	This list box contains the available tasks:
Pre Delay (s)	The length of time, in seconds, that elapses before the current task is performed.
Post Delay (s)	The length of time that elapses after the current task has been implemented and before the next task is started.

Ion Mode	Select the ion mode required by the Ion Mode task from this list box. Note: <i>The Ion Mode list box is only available when Ion Mode is selected in the Task: box.</i>
File Name	Allows a task file to be selected for either the Tune File or Run LC Method task. Enter a path and file name in the text box, or use the Browse button to select a file.
High/On	Flags when the specified Task has a “high” value (for an MS Event Out N task), or is “on” (Syringe Pump).
Low/Off	Flags when the specified Task has a “low” value (for an MS Event Out N task), or is “off” (Syringe Pump).
Pulse... (ms)	When selected, enter the pulse duration, in ms, for an MS Event Out task of type Pulse . Note: <i>The availability of the above three options depends on the currently selected task in the Task list box.</i>

Control Tasks Frame Tool Bar	
	Adds, or inserts a task in the task list, see the <i>To Add a Task to the Task List</i> and <i>To Insert a Task in the Task List</i> sections.
	Modifies a task in the task list.
	Deletes a task from the task list.
	Deletes all the tasks from the task list.

To Add a Task to the Task List

Select the required task from the **Task** list box.

Enter the required parameters.

Select the  button.

*If this is a new task list, the task is added to the end of the list. If a task has been inserted into the task list (see the *To Insert a Task in the Task List* section), all subsequent tasks are added after the inserted task. To add tasks to the end of the list after inserting a task, double click below the last entry in the list and then add the new task.*

To Insert a Task in the Task List

Click on the task list entry before which the new task is to be inserted.

Select the required task from the Task: list box.

Enter the required parameters.

Select the  button.

To Modify a Task in the Task List

Click on the task list entry to be modified.

The task details are displayed in the parameter fields on the left-hand side of the page.

Change the required parameters.

Select the  button.

To Delete a Task in the Task List

Click on the task list entry to be deleted.

The task details are displayed in the parameter fields on the left-hand side of the page.

Select the  button.

To Delete all Tasks in the Task List

Select the  button.

To Change the Width of a Column in the Task List

Position the mouse cursor on the heading between two columns until  appears.

Click and drag the mouse until the column is the required width.

2.10.6 Running Startup and Shutdown Task Files

The automatic startup and shutdown files are run if the MassLynx Shortcut Bar **Startup** or **Shutdown** icon is selected, or the **Shutdown** Editor Menu Bar **Control List, Startup** or **Shutdown** command is selected.

Chapter 3

Tuning

3.1 Overview

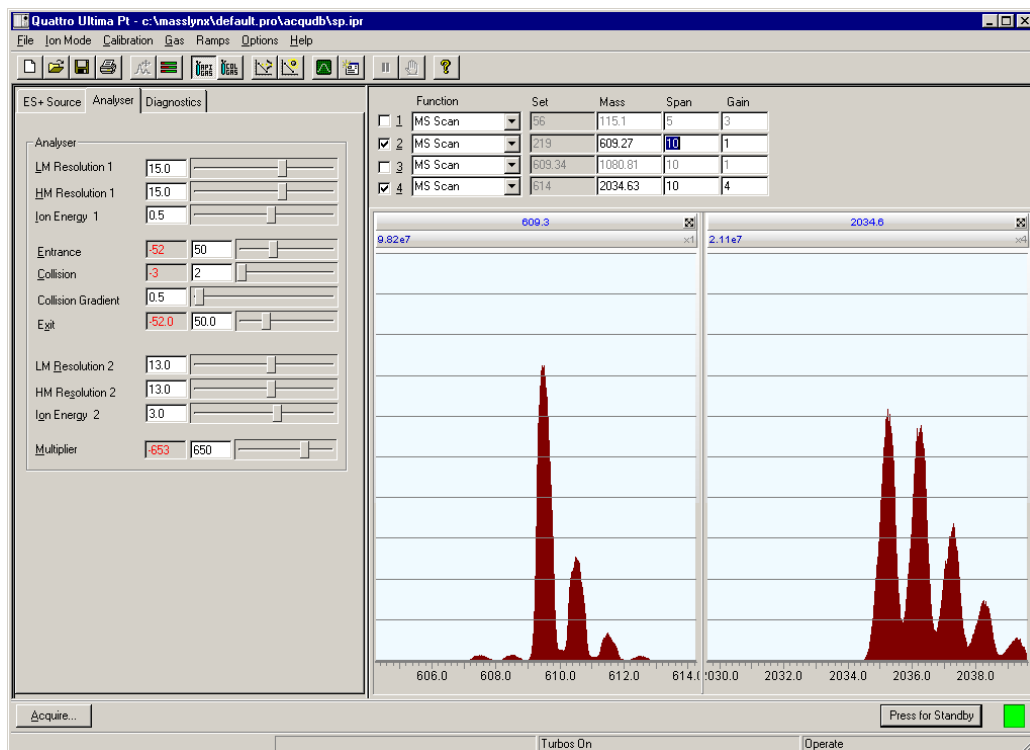

Figure 3-1 Analyser Tune Page

Before sample data are acquired, the instrument should be tuned to obtain the maximum peak resolution and, for the highest mass accuracy, calibrated using a suitable reference compound.

- Consult the relevant section of this manual for information concerning source tuning procedures in the chosen mode of operation.

- Adjust the tuning parameters on the Tune Page **Source** and **Analyser** pages to optimize peak shape and intensity at unit mass resolution. (Unit mass resolution is defined as the peak width at half height, being approximately 0.6 Da.)
- Care should be taken to optimize the value of the collision energy. Note that, in **Daughter** and **Parent** modes, the **Analyser** page **Entrance**, **Collision**, **Collision Gradient**, and **Exit** parameters are interactive.

3.2 The Tune Page

To display the Tune Page:



Select the MassLynx Window **Instrument** Shortcut Bar MS Tune icon, MS Tune .

3

Toolbar:

- Save current tune parameters
- Toggle on/off API gas
- Toggle on/off collision gas
- Toggle on/off cone ramp
- Edit scope settings
- Pause/restart acquisition
- Stop acquisition
- Display the About box
- Create a new tune file

Main Window Parameters:

- ES+ Source: Analyser
- Capillary (kV): 3.15
- Cone: 2.2
- RF Lens 1: 639.3
- Aperture: 100.0%
- RF Lens 2: 2034.6
- Source Temp (°C): 95
- Desolvation Temp (°C): 230
- Gas Flow: Cone (L/hr) 101, Desolvation (L/hr) 821

Scan Function Table:

Function	Set	Mass	Span	Gain
1 MS Scan	ES	115	E	1
2 MS Scan	ES	609.27	E	1
3 MS Scan	ES	1030	E	1
4 MS Scan	ES	2034.6	E	1

Annotations:

- Enabled for MS-MS functions
- Check up to four boxes to display the peaks.
- Click on the arrow to select the scan function.
- Peak Display: Up to four masses can be displayed. Any one can be zoomed to occupy the entire display.
- Select to display the tune parameters for that region.
- Slider bar
- Readback window
- Edit window

Figure 3-2 Toolbar and Tune Page Parameters

3.3 Changing Tune Parameter Settings

Most parameters can be modified in the following ways:

- Drag the slider bar using the mouse.
- Click on the slider bar and use the left and right arrow keys to change the value by one increment.

The edit window updates as the slider bar is activated.

Type a new value into the edit window.

Other parameters have no slider bar; they are changed by typing directly in the edit window.

The speed with which the system responds to changes depends on how quickly the peak display refreshes. For the fastest response, set the scope scan and inter scan times to be as short as possible.

3.4 Source Voltages

The following illustration shows the various components of Quattro Ultima Pt's ion optical system. The table's first column gives the name used throughout this manual to describe a particular component. When appropriate, the second column shows the term used in the current MassLynx NT release.

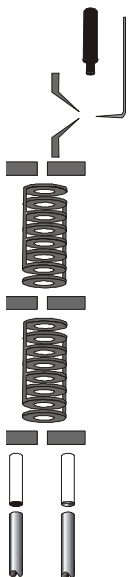

	Tune Page Parameter	ESI+ve	ESI-ve	APcI+ve	APcI-ve
Electrospray Probe	Capillary	+3.0 (kV)	-3.0 (kV)	Not applicable	
APcI Discharge Pin	Corona	Not applicable		5 μ A	5 μ A
Sample Cone	Cone	+50 (V)	-50 (V)	+50 (V)	-50 (V)
First Ion Tunnel	RF Lens 1	+20 (V)	-20 (V)	+20 (V)	-20 (V)
Differential Aperture 1	Aperture	0 (V)	0 (V)	0 (V)	0 (V)
Second Ion Tunnel	RF Lens 2	+0.2 (V)	-0.2 (V)	+0.2 (V)	-0.2 (V)
Differential Aperture 2		Not adjustable			
Prefilter		Not applicable			
Quadrupole Analyser		Not applicable			

Figure 3-3 Source Voltages

The voltages shown are typical for an instrument in good condition. The polarities given are those actually applied to the electrodes. Only positive values need be entered via the Tune Page.

3.5 Printing Tune Information

To print a report, containing a copy of the tune peak information displayed on the screen, along with a record of each parameter setting:

Select the Tune Page Tool Bar  button, or select the Menu Bar **File, Print** command.

This report cannot be configured by the user.

3.6 Experimental Record

Tuning parameters are stored with every data file as part of the experimental record. The tuning parameters for a particular data file can be viewed or printed from the MassLynx **Data Browser** dialog, see the *MassLynx NT User's Guide* for more information.

3.7 Saving and Restoring Tune Parameter Settings

Whole sets of instrument tuning parameters can be saved to disk as a named Instrument Parameter file (of type .ipr), and then recalled at a future date.

A tune parameter file contains the latest settings for the source controls for all supported ionization modes, not just the ionization mode currently selected. Tune parameter files also contain settings for the analyzer, inlet set points, and peak display.

To save the current tune parameters with the existing file name:

Select the Tune Page Tool Bar  button, or select the Menu Bar **File, Save** command.

To save the current tune parameters with a new file name:

Select the Tune Page Menu Bar **File, Save As** command; the **Save As** dialog is invoked.

Enter a new file name or select an existing file from the list displayed.

Select the **Save** button; the **Save As** dialog is closed.

To restore a saved set of parameters:

Select the Tune Page Tool Bar  button, or select the Menu Bar **File, Open** command; the **Open** dialog is invoked.

Select the required tuning parameter file, either by typing its name or by selecting from the list displayed.

Select the **Open** button; the dialog is closed.

3.8 Modifying the Tune Peak Display

The tune peak display is modified using either the tune peak controls, or the mouse directly on the display. If the Tune Page Peak Editor Display is not currently displayed:

Select the Tune Page Tool Bar  button, or the Menu Bar **Options, Peak Editor** command; the Tune Page Peak Editor Display is invoked.

Select the peaks to be displayed by selecting the appropriate check boxes.

For each active peak, select the **Mass, Span** and **Gain**.

To change the **Function**:

Select the **Function** for the peak from the drop down list.

*For MS-MS functions, **Set** is enabled, allowing the mass of the **Parent, Daughter, Neutral Loss, or Neutral Gain** ion to be entered.*

To change the tune **Mass**:

Either:

Click and drag the mouse within the bounds of the axis to draw a “rubber band” around the region of interest.

Release the button.

*This range is redisplayed to fill the window. The mass displayed in the **Mass** box is the mass at the center of the window.*

This operation can be repeated as often as required.

Pressing the  button once displays the previous magnification range and mass, pressing it a second time returns to the default settings.

Or:

Enter a value in the **Mass** box for the required peak and press the keyboard **Return** key.

*This becomes the default, so if the range is altered with the mouse and  is pressed twice, **Mass** returns to this value.*

Or:

Position the cursor at the top of the peak window, just below the line showing the gain.

When  appears, click the left mouse button and drag until the required mass is displayed in the **Mass** box and at the top of the window.

*This becomes the default, so if the range is altered with the mouse, and  is pressed twice, **Mass** returns to this value.*

To change the span of a peak:

Either:

Click and hold the left mouse button at one end of the region of interest and drag the mouse horizontally to the other end.

As the mouse is dragged a “rubber band” stretches out to indicate the selected range.

Do not go beyond the bounds of the axis.

Release the mouse button to re-display the selected range filling the current window.

This operation can be repeated as often as required.

Pressing  once displays the previous magnification range, pressing it a second time returns to the default settings.

Or:

Enter a value in the **Span** box for the required peak and press the keyboard **Return** key.

*This becomes the default, so if the range is altered with the mouse, and  is pressed twice, **Span** returns to this value.*

To change the gain of a peak:

Either:

Double-click on the line above the peak that shows the gain, to double the gain applied to that peak.

Double-click below the peak to halve the gain.

Or:

Click and hold the left mouse button at one end of the region of interest and drag the mouse vertically to the other end.

As the mouse is dragged, a “rubber band” stretches out to indicate the selected range.

Do not go beyond the bounds of the axis.

Release the mouse button to re-display the selected range filling the current window.

Or:

Enter a value in the **Gain** box for the required peak and press the keyboard *Return* key.

3

3.9 Changing the Display

To change the Tune Page display using the mouse:

Right-click in the peak display area to invoke the pop-up menu.



3.9.1 Customize Plot Appearance

The display area for each peak can be individually changed, e.g. the peak color for peak 1 can be red, for peak 2 green, etc.

To change the color of the background and traces and to change the number of traces displayed:

Select the pop-up menu **Customize, Plot Appearance** command; the **Customize Plot Appearance** dialog is invoked.

Error! Not a valid link.

To change the colors on the display:

In the **Primary Colors** frame, select the button adjacent to **Newest Trace:, Background:,** or **Trace Fill:** and select a new color from the invoked dialog.

To change the number of traces:

In the **Storage Mode** frame, enter the required number of traces in the **Visible traces:** box, within the range **2** to **20**.

If more than one trace is displayed, the older traces can be displayed in a different shade to the new ones:

Drag the **Color Interpolation:** slider toward the **full** position. The color of the old traces is shown in the **Trace color sample (new->old):** field.

3.9.2 Trace

Select the pop-up menu **Trace, Outline** option to display the peak outline only.

Select the pop-up menu **Trace, Fill** option to fill the trace with the trace fill color.

Select the pop-up menu **Trace, Min/Max** option to show the minimum and maximum data points only.

Selected options have ticks next to them. Selecting an option a second time deselects it.

3.9.3 Intensity

Select the pop-up menu **Intensity, Relative Intensity** or **Intensity, Absolute Intensity** options as required.

Select the pop-up menu **Intensity, Normalise Data** option to display normalized data.

Selected options have ticks next to them. Selecting an option a second time deselects it.

3.9.4 Grid

Select the pop-up menu **Grid, Horizontal** and **Grid, Vertical** options; these allow horizontal and vertical grid lines to be independently displayed or hidden.

Selected options have ticks next to them. Selecting an option a second time deselects it.

3.10 AutoTune

MassLynx can automatically tune the mass spectrometer in both APcI and ElectroSpray ionization modes. AutoTune ramps the tune parameter settings until they are optimized to give the best intensity, resolution and peak shape.

To run AutoTune:

Select the Tune Page Tool Bar  button to turn on the API gas.

Select the Tune Page  button.

Select the Tune Page Menu Bar **Options, AutoTune** command; the **AutoTune** dialog is invoked.

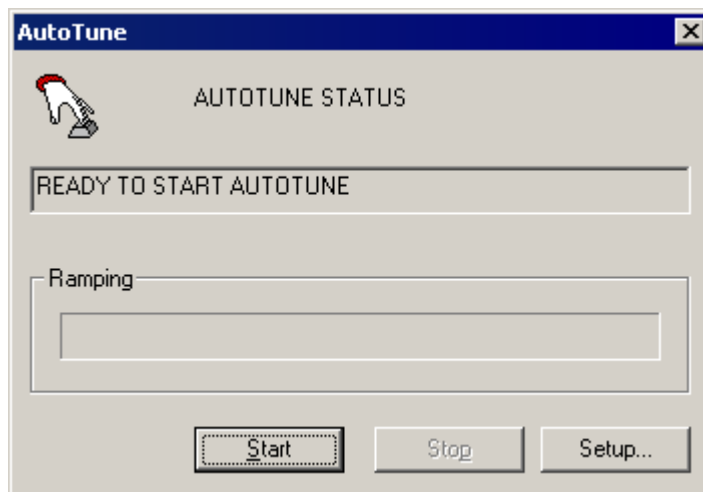

Figure 3-4 Autotune Dialog

Select the **Setup** button; the **AutoTune Setup** dialog is invoked, this is used to define the AutoTune set-up parameters.

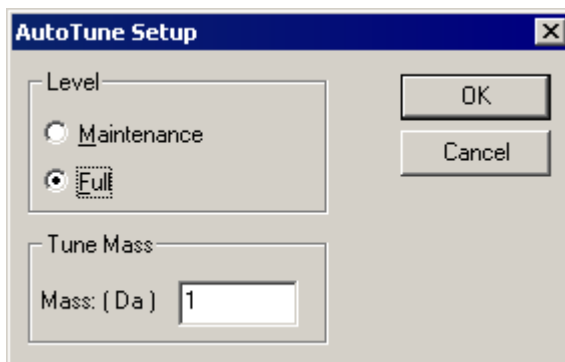

Figure 3-5 Autotune Setup

There are two levels of AutoTune, selected in the **Level** frame:

- **Maintenance.** AutoTune starts from the current tuning parameters set in the Tune Page and can be quicker than a **Full** AutoTune.
- **Full.** AutoTune starts from a default set of tuning parameters.

A **Maintenance** AutoTune can only be performed if the instrument is already reasonably well tuned. If the current tuning is too poor, AutoTune gives an error and requests a **Full** AutoTune.

The **Tune Mass** frame **Mass (Da)** value sets the mass to be tuned on.

When satisfied with the AutoTune set-up parameters:

Select the **OK** button; the **AutoTune** dialog is closed.

Select the **AutoTune** dialog **Start** button.

The AutoTune status bar is updated to show the progress of AutoTune.

The following steps are performed:

- Parameter initialization and instrument checks. These:

Ensure that essential status indicators are read correctly.

Check that values are defined for all the user-controllable instrument parameters and that these are passed to the data system.

Checks that read-backs for these parameters are within specified tolerances.

- Beam detection.
- Focus lens tuning.
- Ion energy tuning.
- High and low mass resolution tuning.

The final four of these steps represent the implementation of the ESP/APcI AutoTune algorithm. This involves changing key parameters, one at a time, to maximize the intensity of a reference peak with respect to that parameter. At present, ESP/APcI Autotuning is carried out with respect to a single user-specified reference peak.

When AutoTune has finished, a status dialog is displayed to notify that AutoTune has been successfully completed.

Select the **OK** button to return to the Tune Page.

The tuning parameters determined by AutoTune are saved to the current tune parameter file.

3

3.11 Ion Mode

Select the required ionization mode from the Tune Page Menu Bar **Ion Mode** menu. The selected mode has a tick next to it.

3.12 Scope Parameters

The scope parameters control the speed with which the tune peak display is updated.

To change the scope parameters:

Select the Tune Page Tool Bar  button, or select the Menu Bar **Options, Scope Parameters** command; the **Scope Setup** dialog is invoked.

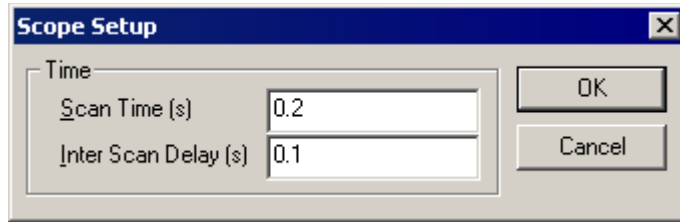

Figure 3-6 Scope Parameters

Make any required changes to the settings.

*The tuning system behaves more responsively if the **Scan Time (s)** and **Inter Scan Delay (s)** are short.*

Select the **OK** button; the **Scope Setup** dialog is closed.

3.13 Gas Controls

To turn a gas on or off:

Select the Tune Page Tool Bar  or  button, or select the required gas from the Tune Page Menu Bar **Gas** menu.

If the gas was previously turned off it is now turned on. A tick mark appears next to a gas if it is turned on.

3

3.14 Ramp Controls

3.14.5 Cone Voltage Ramp

To set up a cone voltage ramp:

Select the Tune Page Menu Bar **Ramps, Cone Ramp Gradient** command; the **Cone Ramp** dialog is invoked.

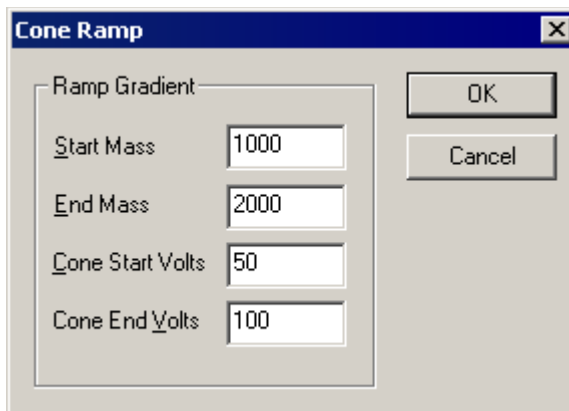

Figure 3-7 Cone Ramp Dialog

Two values of cone voltage are defined at two particular masses. These values define a gradient for the cone voltage that is then extrapolated to cover the full mass range.

Make any changes required and select the **OK** button; the **Cone Ramp** dialog is closed.

To initiate the cone voltage ramp:

Select the Tune Page Tool Bar  button, or select the Menu Bar **Ramps, Use Cone Ramp** command.

A tick mark appears next to the menu item if the cone voltage ramp is selected.

3.14.6 Collision Energy Ramp

To set up a collision energy ramp:

Select the Tune Page Menu Bar **Ramps, Collision Energy Ramp Gradient** command; the **Collision Ramp** dialog is invoked.

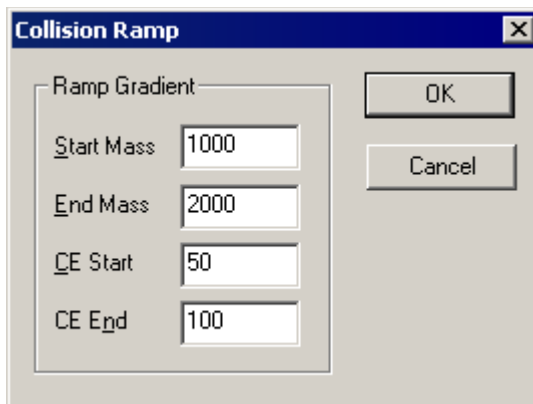

Figure 3-8 Collision Energy Ramp

Two values of collision energy are defined at two particular masses. These values define a gradient for the collision energy voltage that is then extrapolated to cover the full mass range.

Make any changes required and select the **OK** button; the **Collision Ramp** dialog is closed.

To initiate the collision energy voltage ramp:

Select the Tune Page Tool Bar  button, or select the Menu Bar **Ramps, Use Collision Energy Ramp** command.

3.15 Resetting the Zero Level

The zero level (or baseline) can be repositioned by selecting the Tune Page Tool Bar **Error! Not a valid link.** button, or by selecting the Menu Bar **Options, Reinitialize** command.

This command causes the instrument control system to measure the position of the noise signal so that any baseline offset caused by the electronics or instrumentation can be compensated for.

It is advisable to reset the zero level whenever one of the multiplier voltages is changed.

3.16 Controlling Read-Backs

There are three options for displaying system read-backs on the Tune Page; these are selected on the **Readbacks** dialog; this is invoked by selecting the Tune Page Menu Bar **Options, Readbacks** command.

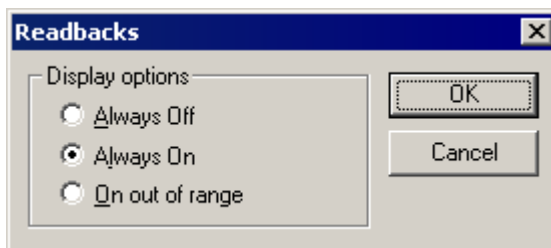

Figure 3-9 Readbacks Dialog

3

Display options Frame	
Always Off	Hides the read-backs.
Always On	Displays all the read-backs.
Out of range	Displays read-backs only when they differ from their defined values by more than 10%.

Some of the read-backs are for diagnostic purposes only, their function being to confirm that a voltage is present. The acceptable variation between the set value and the read-back value varies depending on the particular tune parameter. If there is concern about any reading, contact the local service office for advice.

Chapter 4

Data Acquisition

4.1 Starting an Acquisition

There are two ways of starting an acquisition:

- A single sample acquisition from the Tune Page.
- A multiple sample one from the MassLynx top level screen.

4.2 Starting an Acquisition from the Tune Page

The easiest way to acquire data is directly from the Tune Page.

- Acquisitions can be started and stopped.
- Most of the scanning parameters can be controlled.
- Inlet programs cannot be used.
- Analogue data cannot be acquired.
- Multiple sample sequences cannot be acquired.

To start a single sample acquisition:

Select the Tune Page **Acquire** button; the **Start Acquisition** dialog is invoked.

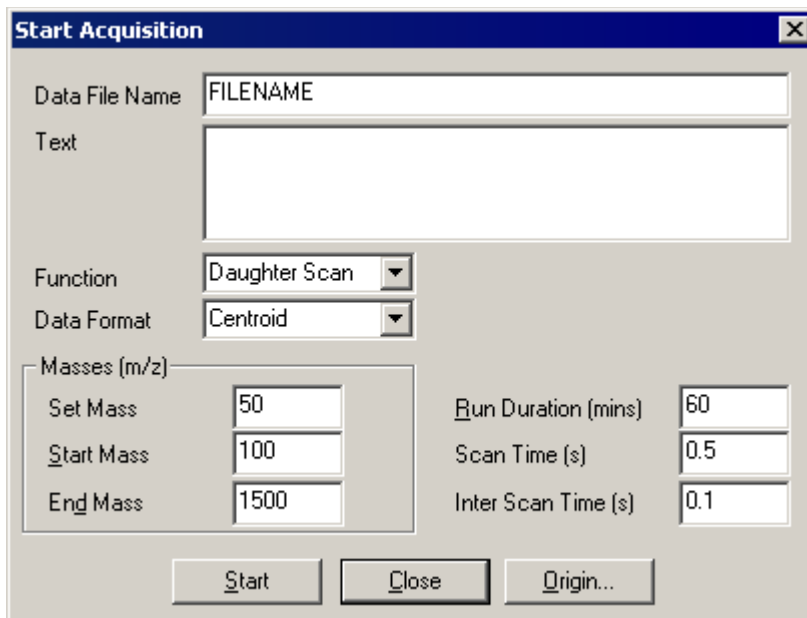

Figure 4-1 Start Acquisition Dialog

Make any required changes to the settings, see below.

Select the **Start** button.

Data File Name	This can be up to 128 characters long. If the file already exists on disk, a prompt is given to rename the file or to overwrite the existing one. The file is written to the current project's data directory.
Text	The sample description is entered in this text box. The description has a maximum length of 74 characters; it can be displayed on any output of the acquired data. To display text on more than one line press CTRL+Return at the end of a line.
Function	<p>The type of acquisition function used to collect the data can be any of the following:</p> <ul style="list-style-type: none"> •MS Scan. •MS2 Scan. •Daughter Scan. •Parent Scan. •Neutral Loss Scan. •Neutral Gain Scan. <p>More information is given in The MS Method Editor section.</p>
Data Format	<p>The Data Format for data collected and stored on disk can be any of the following:</p> <ul style="list-style-type: none"> •Centroid. •Continuum. •MCA. <p>More information on data formats is given later in this chapter.</p>

Masses (m/z) Frame	
Set Mass	The mass (Daughter Mass, Parent Mass, etc.) that is used for the selected function type. This control is disabled if the selected function does not require a set mass
Start Mass	The mass at which the scan starts.
End Mass	The mass at which the scan stops. Note: Start Mass must be lower than End Mass.
Run Duration (mins)	The length of the acquisition, in minutes.
Scan Time (s)	The duration of each scan, in seconds
Inter Scan Time (s)	The time, in seconds, between a scan finishing and the next one starting. During this period, no data are stored.
Origin	Invokes the Sample Origin dialog; this allows additional information about the sample to be analyzed to be entered into the following fields: <ul style="list-style-type: none"> • Submitter • Job • Task • Conditions

4.3 Multiple Sample Data Acquisition

The MassLynx Window contains a Sample List Editor; this is used for defining multiple samples which may be used together to perform a quantitative analysis. The sample list is set up using a spreadsheet style editor, which can be tailored to suit different requirements.

To start a multi-sample acquisition:

Set up a sample list (see the *MassLynx NT User's Guide* for details).

Select the MassLynx Window Menu Bar **Run, Start** command, or select the Tool Bar **Error! Not a valid link.** button; the **Start Sample List Run** dialog is invoked.

Select the **Acquire Sample Data, Auto Process Samples** and **Auto Quantify Samples** options as required.

Enter the required values in the **Run** frame **From Sample** and **To Sample** text boxes.

The default is all samples in the list.

Select the **Priority** and/or **Night Time Process** options as required.

See the MassLynx NT User's Guide for details.

Select the **OK** button, the job is submitted to the MassLynx Queue.

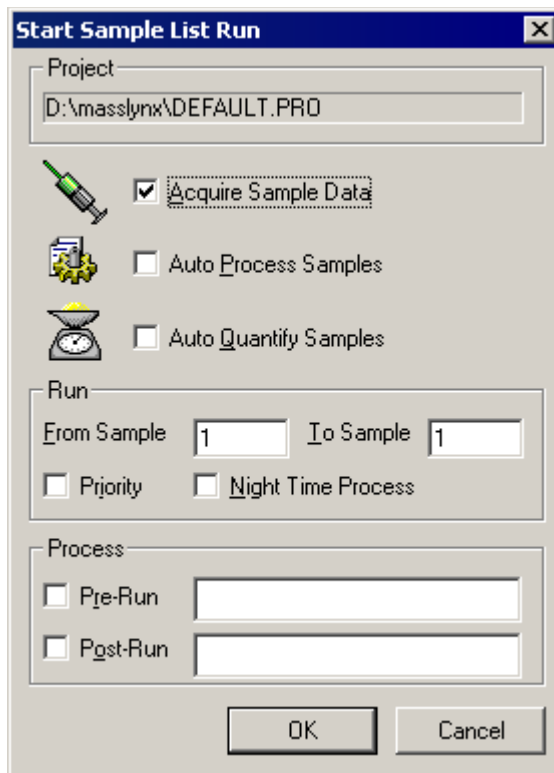

Figure 4-2 Sample List Options

Repeat the above procedure as required.

*Sample lists are added to the Queue and run sequentially unless **Priority** or **Night Time Process** has been selected.*

The controls in the **Process** Frame allow processes to be run before and after the acquisition. The **Pre-Run** control is used to specify the name of a process that is run before acquisition of the files in the Sample List. The **Post-Run** control is used to specify the name of a process that is run after acquisition of the files in the sample list. This could be used, for example, to switch the instrument out of operate and to switch off various gases.

To run a process after each sample in the Sample List has been acquired:

Format the Sample List to display the **Process** column and enter the name of the process to be run for each of the samples.

For the process to automatically operate on the data file which has just been acquired:

Ensure that the MassLynx **Options** dialog **Use Acquired File as Default** option is not selected.

*The MassLynx **Options** dialog is invoked by selecting the MassLynx **Tools** Shortcut Bar, **Options** icon.*

Automated Analysis of the Sample List

To display the quantify samples dialog:

Select the MassLynx **Quantify** Application Bar **Process Samples** icon; the **Quantify Samples** dialog is invoked. This dialog allows automatic processing of data files once they have been acquired. Select the relevant options to perform integration, calibration of standards, quantification of samples and printing of quantification reports. See the *MassLynx NT User's Guide* for more detailed information about using automated sample list analysis.

Select the required options (see below).

Select the **OK** button.

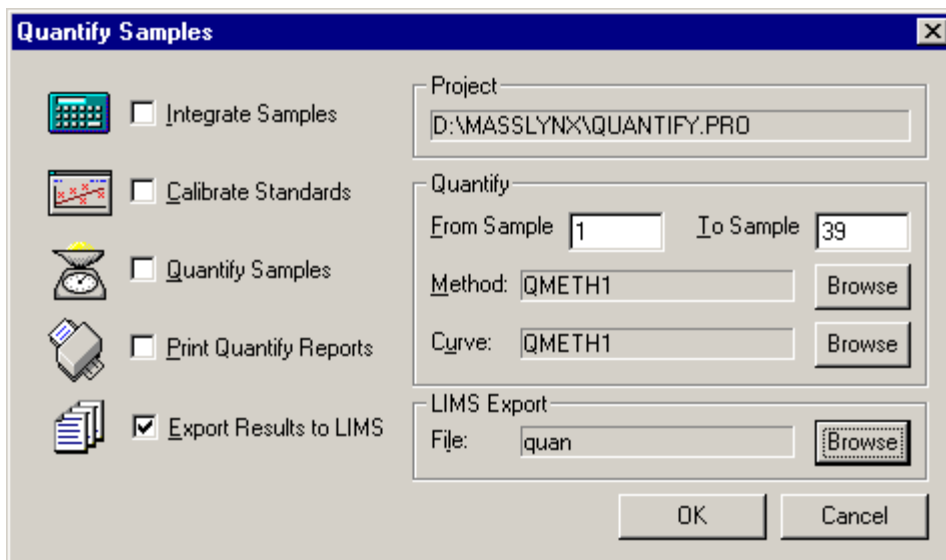

Figure 4-3 Quantify Samples Dialog

Integrate Samples	Integrates all the sample data files named in the Sample List.
Calibrate Standards	Uses Integration results to create Quantify calibration curves. Do not select this option if an existing calibration is to be used; in this case use the Curve:, Browse button to select the desired calibration file.
Quantify Samples	Uses Integration results and Quantify calibration curves to calculate compound concentrations.
Print Quantify Reports	Produces hard copies of the results of integration and quantitation.
Export Results to LIMS	Produces a text file containing the quantitation results details for use with LIMS systems. If this option is selected, the LIMS Export Frame File:, Browse button is enabled; select the Browse button and select a file, or enter the name of a new one, and select the Save button.
Project	The name of the current project. To quantify using a different project, exit this dialog, change the current project, and select the MassLynx Quantify Application Bar, Process Samples icon again.
Quantify Frame	
From Sample... To Sample	Sets the range of samples that will be quantified in the Sample List.
Method: or Curve:	To change the files, select the appropriate Browse button and select a new file.

4.4 Monitoring an Acquisition

Acquisition status is shown on the MassLynx Window in an Information Bar (below the Tool Bar).

The Scan Report Window

The **Scan Report** window, provides a scan-by-scan statistical report of the progress of an acquisition.

The **Scan Report** window is invoked by selecting the Tune Page Menu Bar **Options, Acquisition Status** command.

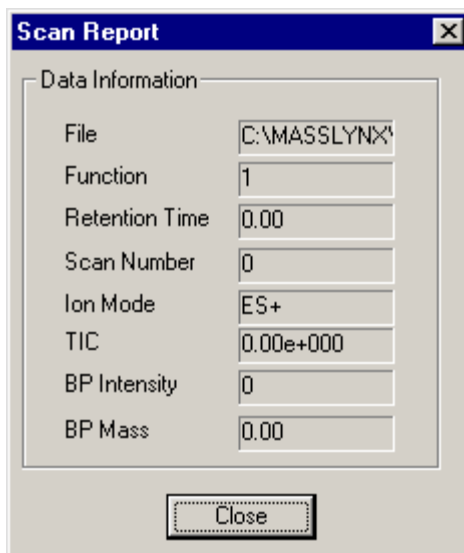

Figure 4-4 Scan Report Window

Chromatogram Real-Time Update

If data are being acquired into a file, the associated chromatograms can be displayed in real time, by selecting the Chromatogram Window Tool Bar **Error! Not a valid link.** button, or the Menu Bar **Display, Real-Time Update** command. The chromatogram display is updated as the acquisition proceeds.

Spectrum Real-Time Update

If data are being acquired into a file, the associated spectra can be displayed in real time, by selecting the Tool Bar **Error! Not a valid link.** button; or the Spectrum Menu Bar **Display, Real-Time Update** command, which invokes the **Spectrum Real-Time Update** dialog.

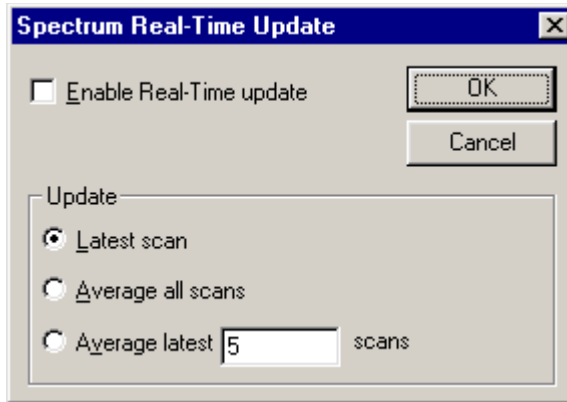



Figure 4-5 Spectrum Real Time Update

Enable Real-Time update	Enables the Real-Time update.
Update Frame	
Latest scan	Displays the latest scan.
Average all scans	Displays the average of all the scans acquired at present.
Average latest...scan	Displays the average of the latest number of scans defined in the text box.

Each spectrum window has a separate real time update switch. The state of the switch for a particular window can be ascertained by checking if the Tool Bar  button is depressed, or by checking the state of the **Spectrum Real-Time Update** dialog **Enable Real-Time update** option.

4.5 Instrument Data Thresholds

MassLynx has several parameters that allow control over how the system pre-processes data before it is sent to the host computer. These parameters are contained in the **Instrument Threshold Settings** dialog; this is invoked by selecting the Tune Page Menu Bar **Options, Set Instrument Threshold** command.

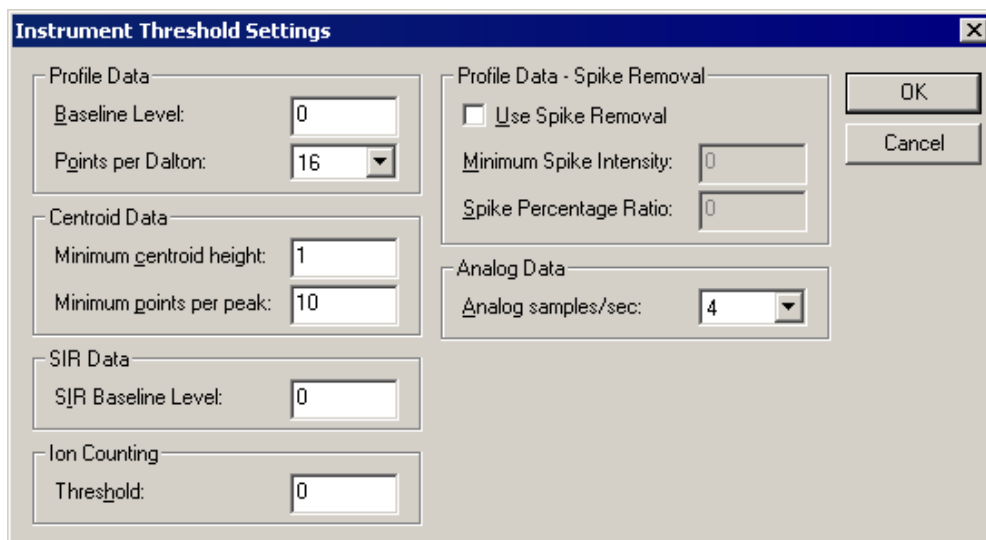

Figure 4-6 Instrument Threshold Settings

Instrument data thresholding allows the user to specify the types of data to acquire and write to disk, and to discard and not write to disk. Limiting the amount of data stored on disk can be particularly desirable when acquiring continuum data and doing long LC runs.

To change data thresholding:

Make the required changes to the information in the **Instrument Threshold Settings** dialog, see below.

Select the **OK** button.

These new parameters are downloaded at the start of the next acquisition scan.

Profile Data

The controls for profile data allow control of the amount of data collected during a continuum data acquisition.

Baseline Level is used to lift or drop the baseline to see more or less of the noise. It is used when **Ion Counting Thresholding** is disabled (set to zero) to set the position of the baseline above zero. The baseline level is typically set to a value of **0**.

A negative baseline may be used. This reduces the noise seen and acts as a form of thresholding to be applied to $\frac{1}{16}$ amu type samples. This takes place after ion counting and therefore has a less significant effect.

To see more noise use a positive value. Do not use a positive value for the baseline level if using ion counting thresholding.

Points per Dalton can have one of three values; **4**, **8**, or **16**.

- Selecting **8** points instead of **16** results in data files approximately half as big.
- Acquiring data at **16 points per Dalton** gives the greatest possible resolution.
- Acquiring data at **4 points per Dalton** gives data with a smoothed appearance.

Centroid Data

Minimum centroid height sets a height below which detected peaks are ignored. This reduces the size of acquired data files and is useful when concentrating on larger peaks of interest.

Minimum points per peak is the minimum number of points that a continuum peak must have to be centroided.

SIR Data

SIR Baseline Level sets the position of the SIR baseline above zero when **Ion Counting Threshold** is not enabled (i.e. set to zero). The baseline level is typically set to **0**. Increasing the value causes the baseline to appear higher.

Ion Counting Threshold

Ion Counting Threshold sets the intensity level below which a data point is ignored. This threshold is applied to all acquisitions, regardless of scanning mode. It is also the most significant of all of the data manipulation variables as it is applied to the raw data first.

When an acquisition is started, the instrument performs a ‘prescan’ with the ion beam switched off, so that the electronic noise level of the acquisition system and its standard deviation can be measured.

Note:

*The MaxEnt algorithm needs to measure noise accurately within a data file. For this reason, **Ion Counting Threshold** should be set to zero when acquiring data to be analyzed using MaxEnt.*

The **Ion Counting Threshold** level entered is multiplied by the standard deviation of the noise to determine the intensity level to be used.

- Values can be set between **0** and **1000**, the higher the number the more data is discarded.
- If a value of zero is entered, the intensity level is set so that it sits in the middle of the noise that means that roughly half of the noise data is acquired.
- A value of **10** places the threshold just above the noise so almost all of the data is acquired.
- If a value of **60** is entered the threshold sits well above the noise level, so very little noise data is acquired.
- A value of **30** is suitable for most data. A value of zero disables the facility.

When using an **Ion Counting Threshold** other than zero, **Profile Data**, **Baseline Level** and **SIR Baseline Level** should be all set to zero.

Ion Counting Threshold should be set so that background noise is removed without significantly reducing the intensity of the smallest peaks of interest.

The following table shows the effects of changing baseline noise and ion counting threshold on background noise and low intensity peaks.











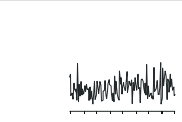
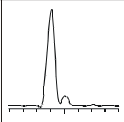





Baseline Level	Ion Count Threshold	Typical Background Noise	Typical Peak Profile	Typical Intensity Reduction	Typical Saving on .DAT File Size
0	0			0	0
1	0				0
2	0				0
5	0				0
0	10			4%	8%
0	20			11%	10%
0	40			37%	61%
0	60			66%	69%
0	250			100%	83%

Figure 4-7 Effects of Changing Threshold Settings

Profile Data - Spike Removal

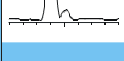
Spikes are distinguished from real data by the fact that they are very narrow and, when compared to their immediate neighbors, very intense. Data points determined to be spikes are removed by setting the value of this data point to the average of its immediate neighbors.

Spike removal involves some additional processing while acquiring and reduces the maximum achievable acquisition rates by approximately 30%.

To perform spike removal during an acquisition:

In the **Instrument Threshold Settings** dialog **Profile Data – Spike Removal** frame:

Select the **Use Spike Removal** option.

This is not reflected in the Tune Page.

Refer to the Tune Page intensities to assess a suitable value for the intensity threshold below which spikes are ignored. Set the **Minimum Spike Intensity** to this value.

*A very low intensity signal may include single ion events that can be combined to produce significant peaks. For this type of data, **Minimum Spike Intensity** should be set to a suitable value such that these single ion events are not discarded as spikes.*

Set a suitable value for the **Spike Percentage Ratio**.

*This ratio is used to determine if a data point is a spike, by comparing the data point to its immediate neighbors. For example, with **Spike Percentage Ratio** set to 33%, a data point is regarded as a spike if its intensity is three times (or more) greater than both its immediate neighbors. A setting of 20% requires an intensity ratio of 5:1 to identify a spike.*

Select the **OK** button to accept any changes.

*Any changes are not downloaded if the **Cancel** button is selected.*

Analog Data

Select the number of samples to acquire per second from the **Instrument Threshold Settings** dialog **Analog Data** frame **Analog samples/sec**: drop-down list.

4.6 System Manager

To check the communications between the MassLynx software and the embedded PC:

Select the Tune Page Menu Bar **Options, Communications Status** command; the **System Manager** dialog is invoked.

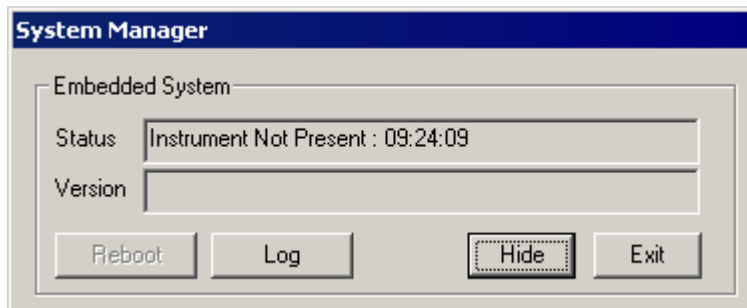

Figure 4-8 System Manager Dialog

4.7 Stopping an Acquisition

To stop the acquisition:

Either:

Select the Tune Page **Stop** button.

Or:

Select the MassLynx Window Menu Bar **Run, Stop** command, or select the Tool Bar **Error! Not a valid link.** button.

Data acquired up to this point are saved.

4.8 The MS Method Editor

Introduction

The MS Method Editor is used to set up the scanning function(s) used during an acquisition. A function list is created, which can be a mixture of different scanning

techniques that can be arranged to run either sequentially, or concurrently, during an acquisition.

Typical uses for mixed function acquisitions are to acquire different SIR groups over different retention windows.

A function list is produced, saved on disk, and then referenced by name when an acquisition is started.

A simple function list is shown above, containing only one function: a centroided mode full scan, between 500 and 1500 amu using ES+ ionization. Immediately above the function bar display is a time scale that shows from when the function is active, and for how long it runs. In this case, the function starts after 5 minutes and then runs for 35 minutes, terminating after a total elapsed time of 40 minutes.

To invoke this dialog:

Select the MassLynx **Instrument** Shortcut Bar **MS Method** icon.

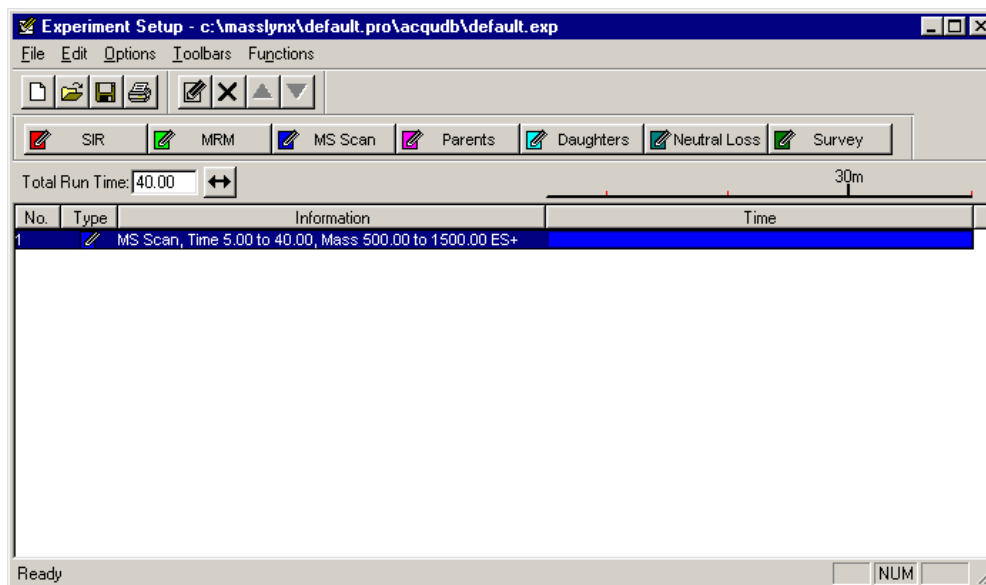

Figure 4-9 Function List Dialog

A more complicated function list, with four SIR functions each running sequentially for 5 minutes, is shown below.

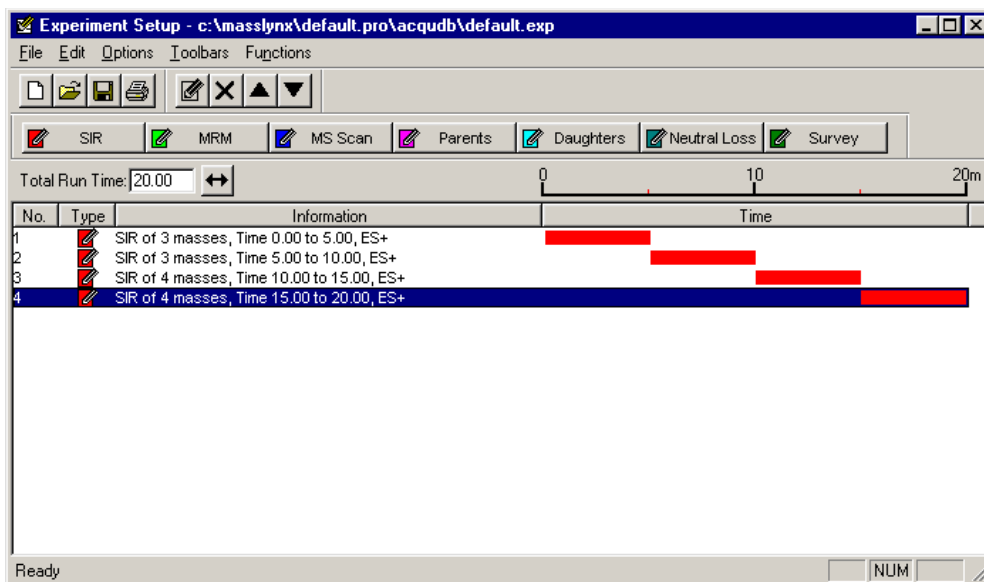









Figure 4-10 SIR Functions

The currently selected function is highlighted and enclosed in a rectangular frame. If the display shows more than one function, a new function can be selected either by clicking with the mouse, or by using the keyboard arrow keys.

The MS Method Editor Tool Bar

The Tool Bar is displayed at the top of the MS Method Editor.

	Creates a new function list.		Edits the selected function.
	Opens an existing function list.		Deletes the selected function.
	Saves the current function list to disk.		Moves the selected function up the function list.
	Prints the current window in portrait format.		Moves the selected function down the function list.

Create a new function of the indicated type:

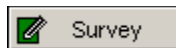
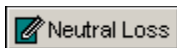
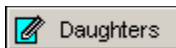
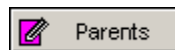
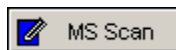
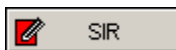

Adding a New Function

To add a new function to the function list:

Select one of the Tool Bar buttons, or select the required function from the Menu Bar **Functions** menu.

MS2 Scan and **Neutral Gain Scan** do not have Tool Bar buttons and can only be created by selection from the **Functions** menu.

The editor for the function type selected is displayed showing default values.

Make any changes required to the parameters and select the **OK** button to add the new function.

The function editors for each scan type are discussed in detail later in this chapter.

Modifying an Existing Function

To modify an existing function:

Select the function in the function list.

Select the Tool Bar  button, or double-click on the function.

This displays the appropriate editor for the function type and allows changes to be made.

The function list display is updated to show any changes.

*Entering a new a value in the MS Method Editor **Total Run Time** box and selecting the  button sets the maximum retention time for the experiment. The ratio of the functions defined is maintained. For example, if two functions are defined, one from 0 to 5 minutes and the other 5 to 10 minutes, then a*

Total Run Time of 10 minutes is displayed. If this value is changed to 20, then the first function now runs from 0 to 10 minutes and the second from 10 to 20 minutes.

Copying an Existing Function

To copy an existing function:

Select the function in the function list.

Select the Menu Bar **Edit, Copy** command and then the **Edit, Paste** command.

Modify the parameters as described above.

Removing a Function

To remove a function:

Select the function in the function list.



Select the Tool Bar  button, or select the Menu Bar **Edit, Delete** command, or press the keyboard *Delete* key.

When asked to confirm the deletion, select the **Yes** button.

Changing the Order of Functions

Functions are displayed in ascending **Start Time** and **End Time** order; this order cannot be changed. For functions that have the same **Start Time** and **End Time**, the order in which they are performed can be changed as follows:

Highlight the required function.

Select the Tool Bar  or  buttons repeatedly, until the function is in the required position.

Setting a Solvent Delay

No data is stored during the solvent delay period, which means that solvent peaks that would normally be seen eluting on the Total Ion Current (TIC) chromatogram are no longer seen.

To set a solvent delay for a function list:

Select the MS Method Editor Menu Bar **Options, Solvent Delay** command, the **Solvent Delay** dialog is invoked.

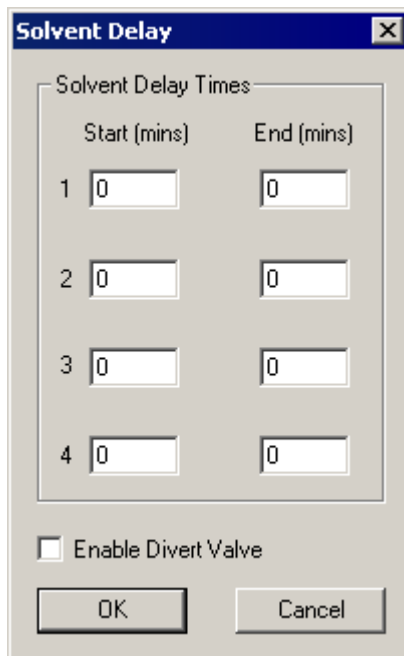

Figure 4-11 Solvent Delay Dialog

For APcI functions, the APcI probe temperature is also shown in the **Solvent Delay** dialog; it is set to the value specified in the Tune Page **APcI Probe Temp** control for the period of the solvent delay.

Analog Channels

If an analog channels hardware option is fitted, up to four channels of analog data can be acquired; these are stored with the data acquired from the mass spectrometer. Analog channels are typically used to collect data from external units such as UV detectors or FID detectors. A reading is made from the external channel at the end of each scan and stored with the data for that scan. The resolution of the chromatography for an analog channel is therefore dependent on the scan speed used to acquire the mass spectrometry data.

To invoke the **Analog Data** dialog:

Select the MS Method Editor Menu Bar **Options, Analog Data** command.

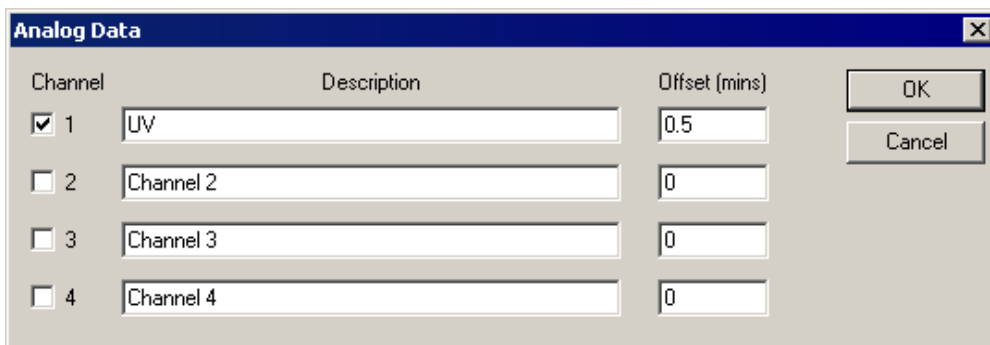

Figure 4-12 Analog Data Dialog

To store data for an analog channel:

Select the box(es) for the required **Channel(s)**.

Enter a textual **Description** for each of the selected analog channels.

*This **Description** is used on the analog chromatogram dialog as the channel description. See “Chromatogram” in the MassLynx NT User’s Guide.*

Enter an **Offset (mins)** to align the external unit with the mass spectrometer.

Select the **OK** button.

Saving and Restoring a Function List

To save a function list:

Select the MS Method Editor Menu Bar **File, Save As** command; the **Save As** dialog is invoked.

Enter a new file name, or select an existing file from the list displayed.

Select the **Save** button.

When the MS Method Editor is closed, a prompt is issued to save any changed function lists.

To restore a saved function list:

Select the MS Method Editor Menu Bar **File, Open** command; the **Open** dialog is invoked.

Select the required function list, either by typing its name, or by selecting it from the displayed list.

Select the **Open** button.

Setting up a Full Scan Function

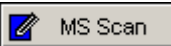
The Full Scan Function Editor is invoked by selecting the MS Method Editor Menu Bar **Functions, MS Scan** command, or selecting the  button; it is used to set up centroid, continuum and MCA functions.

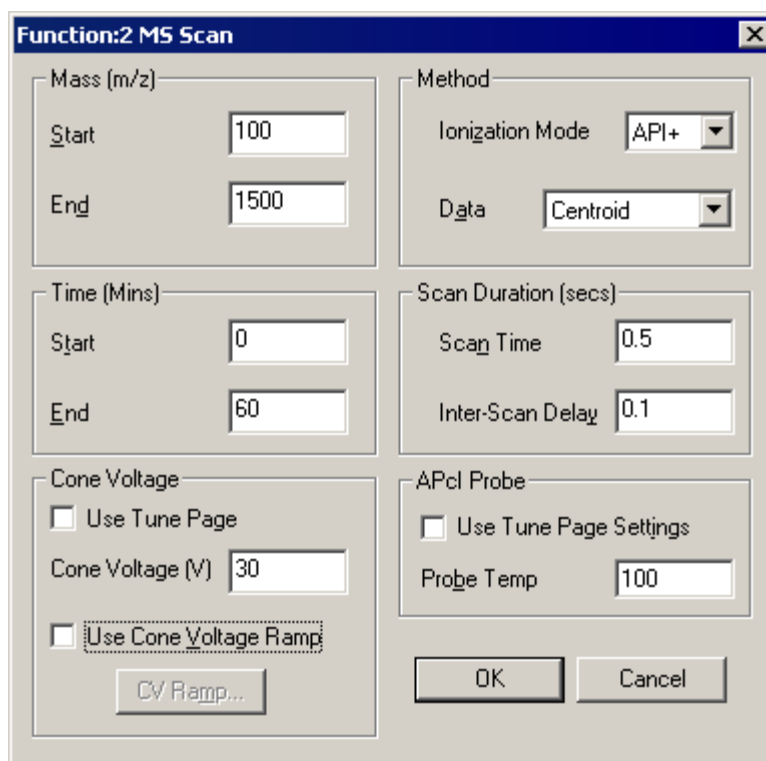

Figure 4-13 Scan Function Editor

Mass (m/z)

Start Mass and **End Mass** specify the masses at which the scan starts and stops. **Start Mass** must be lower than **End Mass**.

Start Time and **End Time** specify the retention time, in minutes, during which this function becomes active, and data are acquired.

Cone Voltage

When **Use Tune Page** is selected, the cone voltage set on the Tune Page at the start of the acquisition is used.

The cone voltage value cannot be altered during acquisition by typing new values into the Tune Page, since the new values are not downloaded during acquisition. This can only be done by acquiring from the Tune Page.

To apply a ramp to the cone voltage:

Select the **Use Cone Voltage Ramp** option.

Select the **CV Ramp** button; the **Cone Ramp** dialog is invoked.

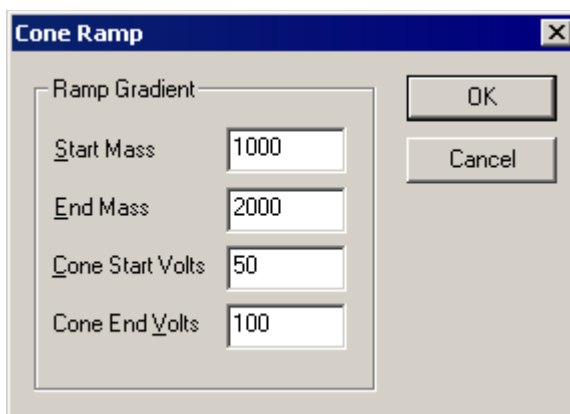

Figure 4-14 Cone Ramp Dialog

The four parameters define a gradient for the cone voltage that is then extrapolated to cover the full mass range of the function.

Method

Ionization Mode specifies the ionization mode and polarity to be used during acquisition.

Data specifies the type of data to be collected and stored on disk. There are three options:

- **Centroid** stores data as centroided, intensity and mass assigned peaks. Data are stored for every scan.

- **Continuum.** The signal received by the interface electronics is stored regularly to give an analog intensity picture of the data being acquired. Data are not centroided into peaks, but are stored for every scan.

Because data are acquired to disk at all times, even when no peaks are being acquired, continuum data acquisition places some extra burden on the acquisition system as compared to centroided acquisition. Data files tend to be significantly larger than centroided ones and the absolute scanning speed (amu/sec) is slower.

It is possible, however, to set a threshold below which the data are not stored. Depending on the nature of the data acquired, this can greatly reduce these effects. The threshold can be set so that data considered to be ‘noise’ can be discarded, thus improving data acquisition speed and reducing data file sizes. For more information about setting instrument data thresholds, see the *Instrument Data Thresholds* section earlier in this chapter.

- **Multi Channel Analysis (MCA).** MCA data can be thought of as ‘summed continuum’, with only one intensity accumulated scan being stored for a given experiment. As each scan is acquired, its intensity data is added to the accumulated summed data of previous scans.

An advantage of MCA is that random noise does not accumulate as rapidly as real data and therefore effectively averages out over a number of scans. This emphasizes the real data and improves the signal to noise ratio.

A further advantage of MCA is that because data is written to disk only at the end of an experiment, scanning speeds can be increased and significantly less storage space is required.

The disadvantage of MCA is that, as there is only one scan, it cannot be used for time resolved data.

For MCA, **Scans to Sum** defines the number of scans to sum to create a spectrum.

Scan Duration (secs)

Scan Time specifies the duration of each scan in seconds, while **Inter-Scan Delay** specifies the time in seconds between a scan finishing and the next one starting. No data are stored during this period.

APCI Probe

Probe Temp, in degrees centigrade, is enabled when **Ionization Mode** is set to **APCI**.

When **Use Tune Page Settings** is selected, the APCI probe temperature set on the Tune Page at the start of the acquisition is used. This control is enabled when the **Ionization Mode** is set to **APCI**.

The APCI probe temperature value cannot be altered by typing new values into Tune Page during the acquisition since the new values are not downloaded during the acquisition. This can be done by acquiring from the Tune Page.

Setting up a SIR Function

Function:2 SIR

Mass (m/z)	Dwell (Secs)	Cone (Volts)

Method

Ionization Mode: ES+

Inter-Channel Delay: 0.02

Inter-Scan Delay: 0.1

Repeats: 1

Span: 1

Use Tune Cone Settings

Retention Window (Mins)

Start: 0

End: 60

APCI Probe

Use Tune Page Settings

Probe Temp: 100

Buttons: Add, Change, Delete, Clear All, OK, Cancel

Figure 4-15 SIR Function Setup Dialog

The SIR (Selected Ion Recording) technique is typically used in situations where only a few specific masses are to be monitored. Since most of the data acquisition time is spent on these masses, the technique is far more sensitive than full scanning.

The SIR editor is used to enter the masses to be monitored, along with their dwell times, spans and inter-channel delay times.

To invoke the SIR function editor:

Select the MS Method Editor Menu Bar **Functions, SIR** command, or select the  button.

Many of the fields are described above for the full scan editor. Only those that differ are described below.

Channels

Up to 32 masses can be monitored. To enter a mass:

Type suitable values into the **Mass (m/z)**, **Dwell (Secs)** and **Cone (Volts)** boxes.

Select the **Add** button.

Dwell (Secs) *specifies the length of time, in seconds, for which the highlighted mass is monitored.*

To modify existing settings:

Double-click on a mass in the list.

This displays the values for the selected mass in the edit fields.

Change **Mass (m/z)**, **Dwell (Secs)** and **Cone (Volts)** as required.

Select the **Change** button to update the values in the list.

Method

Inter Channel Delay specifies the time, in seconds, between finishing monitoring the highlighted mass and starting monitoring the next mass in the function.

Repeats is only relevant for experiments having more than one function and specifies the number of repeats of the function.

Span specifies a small mass window applied centrally about the highlighted mass. During acquisition, this range is scanned over the specified **Dwell** time. A span of zero can be set to simply 'sit on' the specified mass.

Retention Window

Start and **End** together specify the retention time, in minutes, during which this function is active.

Setting up MS-MS Scanning Functions

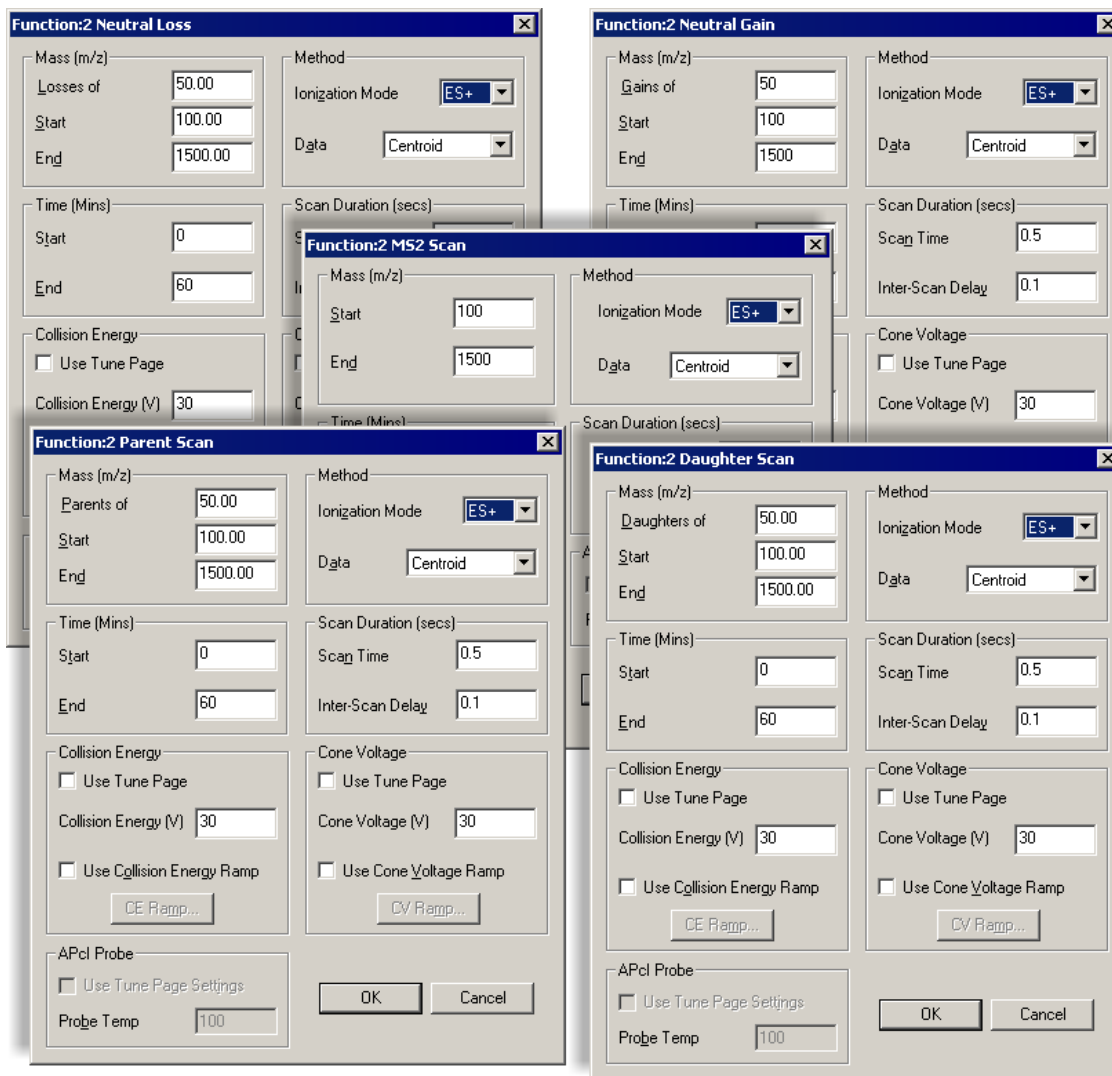

Figure 4-16 Setting Up MS-MS Scanning Functions

Many of the fields in the MS-MS editors are similar to those in the Full Scan Editor. Only fields that differ significantly are described below.

Mass (m/z) Frame

Daughter Mode

This is the most commonly used MS-MS mode; it is used to look at fragmentations of a particular ion. MS1 is set to the parent mass using **Daughters of**, and is not scanned.

The resolution of MS1 can be lowered until the peak width at the base is two masses wide without the daughter spectrum containing any ions from the adjacent parent masses.

(In Auto mode the Collision Gradient = 3.0 V.)

Start and **End** specify the mass range to be scanned by MS2.

It is possible to select the daughter mass to be greater than the parent (precursor) mass. This can occur when a multiply charged ion fragments and loses charge, forming ions of higher m/z .

Parent Mode

This mode is used to look for the parent of a particular fragment.

MS2 is set to the mass of the fragment, using **Parents of**, and is not scanned.

Start and **End** specify the mass range over which MS1 is scanned. **Start** is normally set just below **Parents of**, and **End** to a value above the highest expected parent mass.

There are often several masses from which a daughter may come, hence any one fragment is derived from a number of different peaks.

(In Auto mode the Collision Gradient = 7.0 V.)

MS2 Mode

In this mode, MS2 is resolving, while MS1 transmits ions over a wide mass range. While this scanning mode can be used for acquiring data, it is mostly used in the Tune Page, for setting and optimizing the acquisition conditions.

(In Auto mode the Collision Gradient = 0.5 V.)

Neutral Loss Mode

In this mode, the peak in a spectrum that gives the neutral loss specified in **Losses of** is detected. The precursor mass is scanned in MS1, and MS2 is scanned at this mass less the

neutral loss mass. Starting masses are therefore detected on the mass scale of MS1. **Start** (for MS1) should be greater than **Losses of** to give MS2 a valid start mass.

(In Auto mode the Collision Gradient = 7.0 V.)

Neutral Gain Mode

This is an infrequently used mode, since the mass selected by MS2 is higher than that of MS1. It is applicable to studies where a precursor ion gains mass by ion molecule reaction or where multiply charged ions fragment into particles with a higher m/z value.

(In Auto mode the Collision Gradient = 7.0 V.)

Collision Energy Frame

This specifies the collision energy, in electron volts, to be used for the collision cell during the scan.

When **Use Tune Page** is selected, the collision energy set on the Tune Page is used. If the setting needs to be adjusted during an acquisition, the acquisition must be started from the Tune Page.

To apply a ramp to the collision energy:

Select the **Use Collision Energy Ramp** option.

Select the **CE Ramp** button; the **Collision Ramp** dialog is invoked.

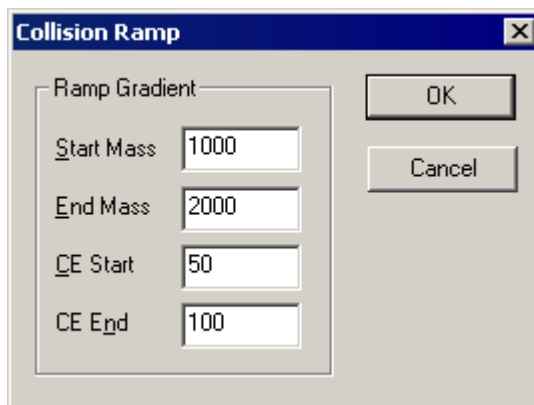

Figure 4-17 Collision Ramp Dialog

The four parameters define values of collision energy for two particular masses. This collision energy gradient is then extrapolated to cover the full mass range of the function.

Setting up a MRM Function

Multiple Reaction Monitoring (MRM) functions are set up in much the same way as SIR functions, but allow a number of MS-MS transitions (fragmentations) between MS1 and MS2 to be monitored.

Parent (m/z)	Daughter (m/z)	Dwell (Secs)	Cone (Volts)	Coll Energy (eV)
50	250	.08	30	50
50.00	250.00	0.08	30.00	50.00
502.30	250.00	0.08	30.00	50.00

Figure 4-18 MRM Editor Dialog

All fields in the MRM editor are similar to those already described.

Setting up a Survey Function; the Survey Scan Dialog

Survey scans are used to search for precursor ions. To access the Survey Scan dialog:

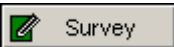
Select the MS Method Editor Menu Bar **Functions, Survey Scan** command,
or select the  **Survey** button.

The function list editor does not add survey functions to the list if non-survey functions are present.

Survey Scan Dialog: Survey and MSMS Template Pages

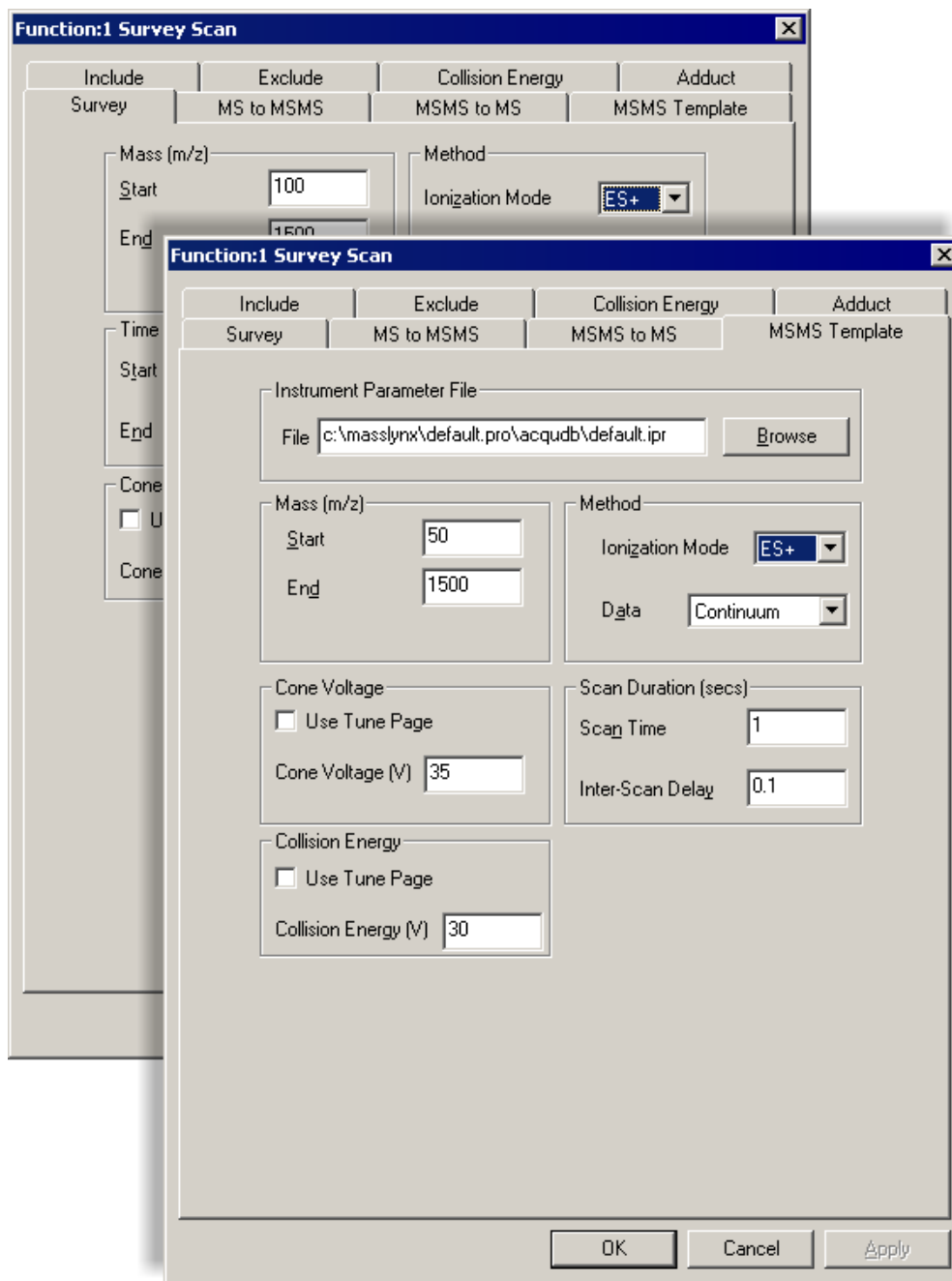

Figure 4-19 Survey Scan Dialog: Survey and MSMS Template Pages

These pages allow the parameters to be set for MS and MS-MS scanning during the survey, and are similar to normal function editor pages. The **MSMS Template** page also allows the user to select the required Instrument Parameter File (.ipr), see the *Saving and Restoring Parameter Settings* section, in the *Tuning* chapter, for details.

Survey Scan Dialog: MS to MSMS Page

Function:1 Survey Scan

Include Survey | Exclude MS to MSMS | Collision Energy MSMS to MS | Adduct MSMS Template

MS to MSMS Switch Criteria

TIC

Intensity

Threshold: 10

Detection Window (Da): 0.5

Number of Components: 1

Retention Time Window (s): 1

Charge State

Tolerance Window +/- (Da): 3

Extraction Window (Da): 2

Precursor Selection

Everything

Included Masses only

Included Masses Take Priority

Detected Precursor Inclusion

Auto Exclude

Always Include

Include After Time (s): 10

Data

Discard uninteresting survey scans

OK Cancel Apply

Figure 4-20 Survey Scan Dialog: MS to MSMS Template Page

MS to MSMS Switch Criteria Frame	
TIC	When selected, MSMS scanning commences when the TIC of the spectrum rises above the specified Threshold value.
Intensity	When selected, MSMS scanning commences when the intensity of the largest peak rises above the specified Threshold value.
Threshold	The value at which MSMS scanning commences (TIC or Intensity).
Detection Window (Da)	When a peak is detected, no other peaks are looked for within the mass range specified by \pm the value of Detection Window , centered about the detected peak.
Number of Components	Selects the maximum number of “interesting” peaks to detect from an MS scan. The software will attempt to find the Number of Components from an MS spectrum. Once the maximum number of components in the spectrum for the specified criteria are found, new MSMS functions are generated automatically and a switch to MSMS mode is performed.
Retention Time Window (s)	The Retention Time Window is used by the Include (see the Survey Scan Dialog: Include Page section) and Exclude (see the Survey Scan Dialog: Exclude Page section) lists. A mass will be included or excluded if it appears at the specified retention time \pm the Retention Time Window (s) value.

Charge State Frame	
Tolerance Window +/- (Da)	If a peak is detected, but is outside the Tolerance Window of where it should be, it is ignored by the Charge State Recognition routines.
Extraction Window	The window around the base peak for data to be extracted, in Da. For example, if the Extraction Window is 1 Da, the window will be 0.5 Da either side of the base peak. The extracted data is then used to calculate the Charge State.

Precursor Selection Frame	
Everything	Monitors all the valid masses satisfying the selection criteria.
Included Masses only	Monitors only the masses in the Include List (see the Survey Scan Dialog: Include Page section).
Included Masses Take Priority	Masses on the Include List (see the Survey Scan Dialog: Include Page section) are given priority. If no precursors are found then other valid masses are monitored. Note: A mass is valid if it is not on the Exclude List (see the The Exclude Mass Dialog section), and it satisfies the precursor selection criteria.

Detected Precursor Inclusion Frame	
Auto Exclude	Only switch on the masses once during an acquisition.
Always Include	Never exclude any masses from being switched on.
Include After Time (s)	Once a mass has been switched on, it will be excluded for the time specified in the adjacent text box. Once the retention time of a mass has exceeded the Include After Time value, the mass can be considered as an “interesting” peak again.
Data Frame	
Discard uninteresting survey scans	Stores only the survey scans that detect precursor ions. This saves on disk space as survey scans that contain no relevant data are rejected.

Survey Scan Dialog: MSMS to MS Page

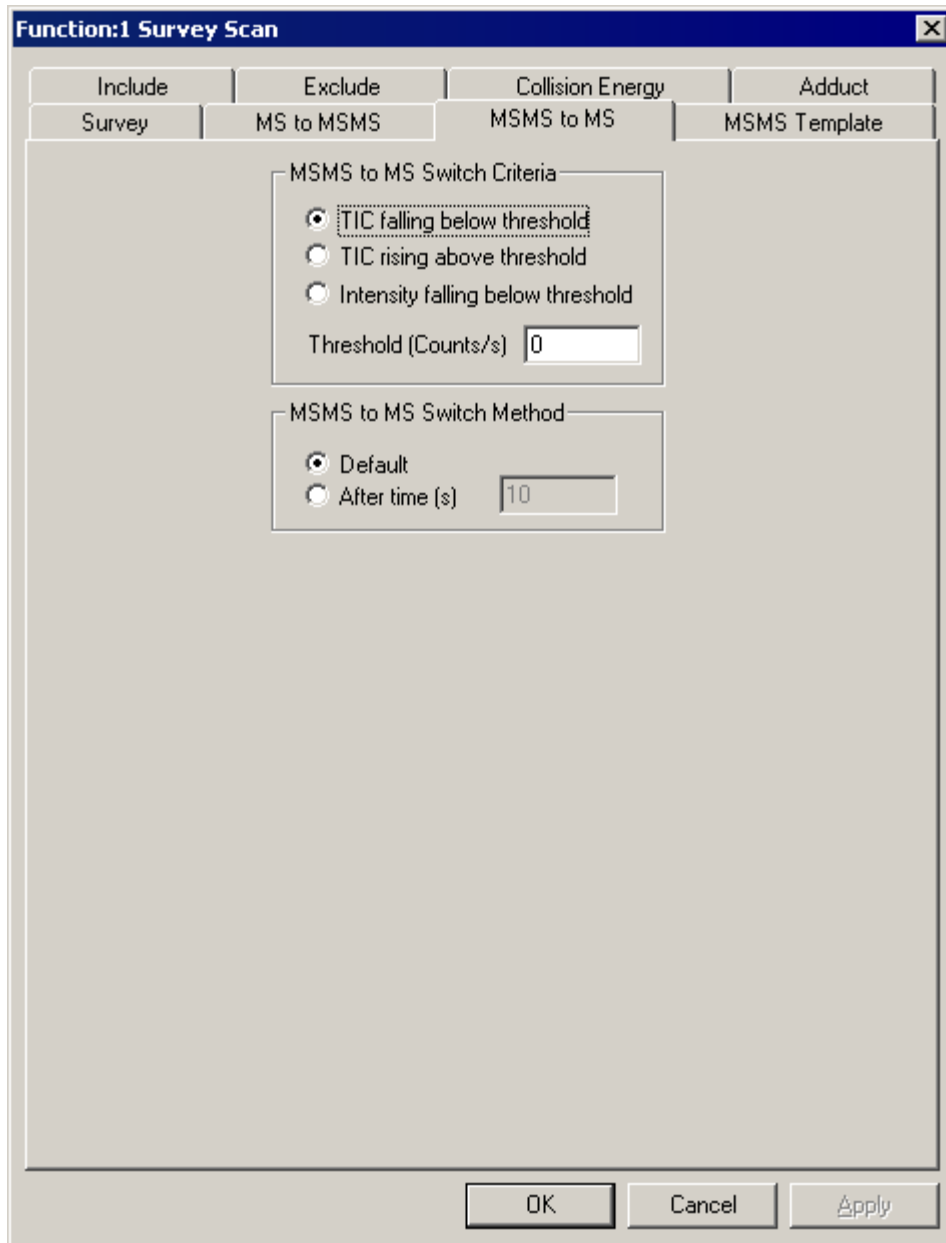

Figure 4-21 Survey Scan Dialog: MSMS to MS Page

When MSMS functions have been generated, they are carried out in parallel until the conditions for switching to MS are satisfied. When all MSMS functions have stopped, the MS survey function is again carried out.

MSMS to MS Switch Criteria Frame	
TIC falling below threshold	When selected, MS scanning commences when the TIC of the spectrum falls below the specified Threshold value.
TIC rising above threshold	When selected, MS scanning commences when the TIC of the spectrum rises above the specified Threshold value.
Intensity falling below threshold	When selected, MS scanning commences when the intensity of the largest peak falls below the specified Threshold value.
Threshold (Counts/s)	The value at which MS scanning commences.

MSMS to MS Switch Method Frame	
Default	The MSMS function stops when the MSMS to MS switch criteria are met.
After time (s)	The MSMS function stops when the MSMS to MS switch criteria are met, or otherwise when the specified time has elapsed.

Survey Scan Dialog: Include Page

Function:1 Survey Scan

Survey | MS to MSMS | MSMS to MS | MSMS Template

Include | Exclude | Collision Energy | Adduct

Include Mass

Range

File

Mass	Retention Time	Collision Energy	Cone Voltage	Charge State	Scan
------	----------------	------------------	--------------	--------------	------

Include Window +/- (mDa)

Charge State

Use Include By Charge State

Charge State(s): Number of Include Components:

Figure 4-22 Survey Scan Dialog: Include Page

The Include List is a list of the masses that are “interesting” and prompt a switch to MSMS operation. The Include List would generally be used with the **MS to MSMS** page **Included Masses only**, or **Included Masses Take Priority** option selected.

Include Mass Frame	
Range	Enter the required masses, or range of masses, to be used from those in the Include List Box. Separate individual masses by commas; use an underscore to denote a range of masses, e.g. 510, 520, 550_600, 700 .
File	When selected, the name of the file in which the Include List is to be stored can be entered in the adjacent text box; alternatively, use the Browse button to select an existing file.

Include List Box	
New	Resets all the options and clears the Include List.
Add	Invokes the Include Masses dialog; this allows the Include List to be edited, see <i>The Include Masses Dialog</i> section.
Delete	Deletes the selected entry from the List Box.
Save	Saves the Include List details to an existing file.
Save As	Saves the Include List details to a new file.
Include Window +/- (mDa)	Defines the Include Window size, in mDa. If an interesting mass is detected from the survey scan, and it is close enough, (within the Include Window) to the specified include mass, and all other criteria are met, the mass will be switched on. If the mass is outside the Include Window , it will not be switched on.

Charge State Frame	
Use Include By Charge State	Select to use charge states.
Charge State(s)	Enter the required charge state(s) in this text box.
Number of Include Components	Enter the required number of components to be included.

The Include Masses Dialog

The **Include Masses** dialog is invoked from the **Survey Scan** dialog: **Include** page by:

Selecting the **Add** button, in order to add information to the List Box.

Double-clicking on an entry in the List Box, in order to edit that entry.

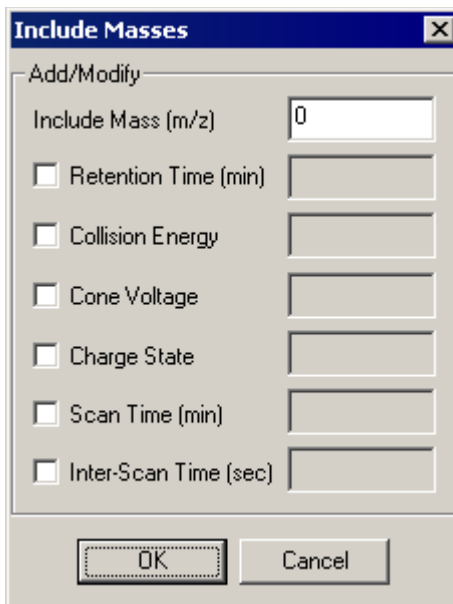

Figure 4-23 Include Masses Dialog

To enter a value, select the check box for the required option, and enter the value in the adjacent text box.

Add/Modify Frame	
Include Mass (m/z)	The specified Mass to include from the Function Switching process.
Retention Time (min)	If the specified mass elutes at the specified Retention Time , and is within the MS to MSMS page Retention Time Window (s) value, the mass is considered to be on the include list. This allows masses eluting from a column to be included as a mass of interest.
Collision Energy	The collision energy to be used to split the detected mass for the MSMS scans.

Cone Voltage	The Cone Voltage value to be applied during the MSMS scans.
Charge State	Include the mass by its charge state.
Scan Time (min)	The Scan Time, in minutes, to be used during MSMS scans for the detected mass.
Inter-Scan Time (sec)	The Inter-Scan Time to be used during MSMS scans for the detected mass.

Survey Scan Dialog: Exclude Page

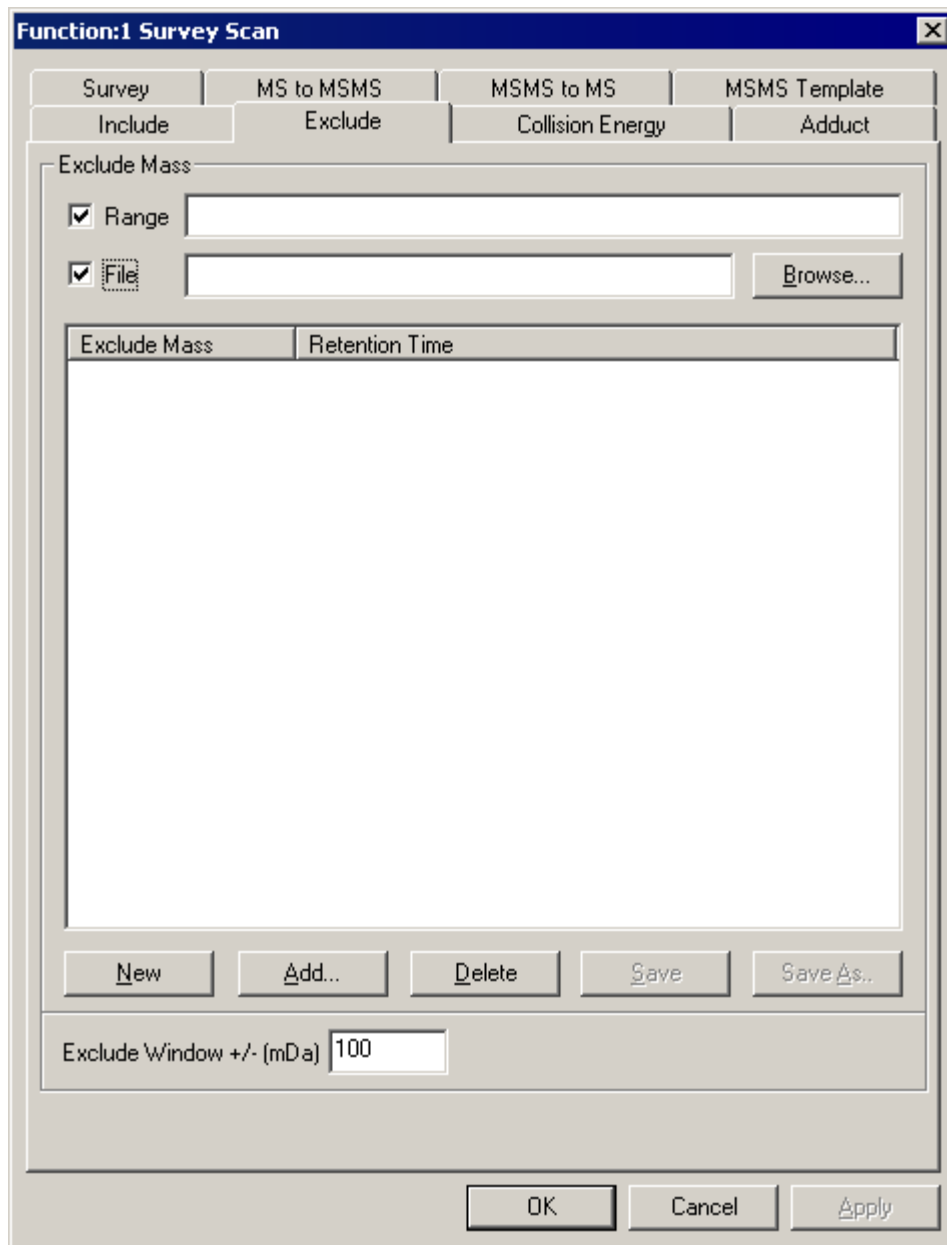

Figure 4-24 Survey Scan Dialog: Exclude Page

The Exclude List is a list of the masses that are to be ignored (i.e. specified as not being “interesting”) such that there is no switch to MSMS operation.

Exclude Mass Frame	
Range	Enter the required masses, or range of masses, to be used from those in the Exclude List Box. Separate individual masses by commas; use an underscore to denote a range of masses, e.g. 510, 520, 550_600, 700 .
File	When selected, the name of the file in which the Exclude List is to be stored can be entered in the adjacent text box; alternatively, use the Browse button to select an existing file.
Exclude List Box	
New	Resets all the options and clears the Exclude List.
Add	Invokes the Exclude Mass dialog; this allows the Exclude List to be edited, see The Exclude Mass Dialog section.
Delete	Deletes the selected entry from the List Box.
Save	Saves the Exclude List details to an existing file.
Save As	Saves the Exclude List details to a new file.
Exclude Window +/- (mDa)	Defines the Exclude Window size, in mDa. If a mass is detected from the survey scan, it is close enough, (within the Exclude Window) to the specified exclude mass, and all other criteria are met, the mass will be ignored.

The Exclude Mass Dialog

The **Exclude Mass** dialog is invoked by the **Exclude Page**, **Add** button, or by double-clicking on an entry in the List Box.

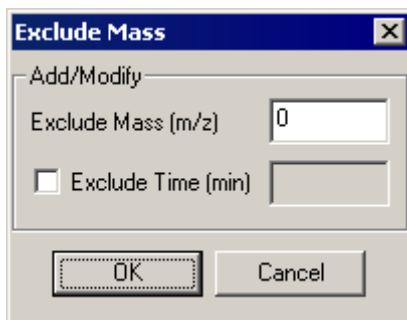

Figure 4-25 Exclude Mass Dialog

Add/Modify Frame	
Exclude Mass (m/z)	The specified Mass to exclude from the Function Switching process.
Exclude Time (min)	If the Exclude Mass is detected at the Exclude Time in minutes, and is within the MS to MSMS page Retention Time Window (s) value, it will be excluded from the Function Switching process.

Survey Scan Dialog: Collision Energy Page

Function:1 Survey Scan

Survey MS to MSMS MSMS to MS MSMS Template

Include Exclude Collision Energy Adduct

Default Collision Energy

Use Default Collision Energy

Collision Energy Profile

Use Collision Energy Profile

File Browse...

Modify...

Charge State Recognition

Use Charge State Recognition

Maximum Number Of Charge States:

CS1 File Browse...

CS2 File Browse...

CS3 File Browse...

CS4 File Browse...

Modify...

OK Cancel Apply

Figure 4-26 Survey Scan Dialog: Collision Energy Page

This page allows the user to set up or select one of three Collision Energy options.

Default Collision Energy Frame	
Use Default Collision Energy	Uses a single default value, which is configured on the MSMS Template Page. It allows either the Tune Page value or a user entered value to be used. If the Tune Page value is to be used this value can be changed during the scan, but it only comes into affect on the next switch from MS to MSMS.

Collision Energy Profile Frame	
Use Collision Energy Profile	<p>Selecting this option enables the controls in the Collision Energy Profile frame.</p> <p>The Collision Energy Profile is a range of Collision Energy values, which are associated with a specified mass. The user can enter up to a maximum of five different Collision Energy values.</p> <p>When an interesting mass is detected in an MS scan and the mass is on the Collision Energy Profile list, these Collision Energy values are used during the mass' MSMS scans.</p>
File	The file name of the Collision Energy Profile file.
Browse	Allows the user to browse for the required Collision Energy Profile file.
Modify	Invokes the CE Profile dialog; this allows the user to set up a table of collision energy profiles for masses that are being switched on. See <i>The CE Profile Dialog</i> section.

Charge State Recognition Frame	
Use Charge State Recognition	<p>Selecting this option enables the controls in the Charge State Recognition frame.</p> <p>When an interesting mass is detected in an MS scan its Charge State is calculated. Using the mass and its Charge State, a Collision Energy value can be obtained from the entered Charge State table. This value is then used during MSMS scanning.</p> <p>The Include Page, Include by Charge State and the Collision Energy Page, Use Charge State Recognition functionalities can be used independently, or both can be configured to combine their individual functionalities, see the <i>Charge State Recognition Functionality</i> section for further details.</p>
Maximum Number Of Charge States	<p>Enter the number of Charge States to be considered (maximum four) in this text box; the following CSx File text boxes are enabled, as appropriate, by this action.</p>
CS1 File, etc.	<p>Enter the file name of the required Charge State file, or use the adjacent Browse button to search for a file.</p>
Modify	<p>Selecting this button invokes the Modify Charge State dialog; this allows the user to create, or modify Charge State files. See Collision Energy Dialog</p> <p><i>The Modify Charge State Dialog</i> section for details.</p>

The CE Profile Dialog

The **CE Profile** dialog is invoked by the **Survey Scan** dialog, **Collision Energy** page, **Collision Energy Profile** frame, **Modify** button. It allows the user to set up a Collision Energy Profile Table for masses that are being switched on.

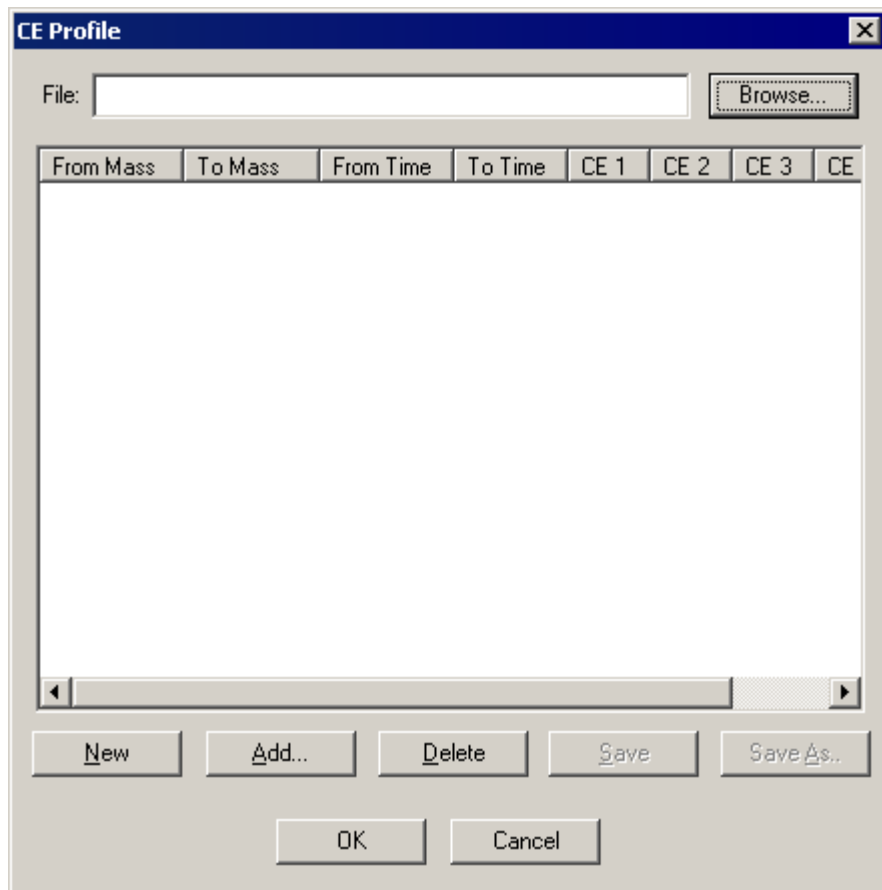

Figure 4-27 Collision Energy Profile

Selecting the **Add** button, or double-clicking on an entry in the Table invokes the **Collision Energy** dialog; this allows the user to add new entries to the Collision Energy Profile Table.

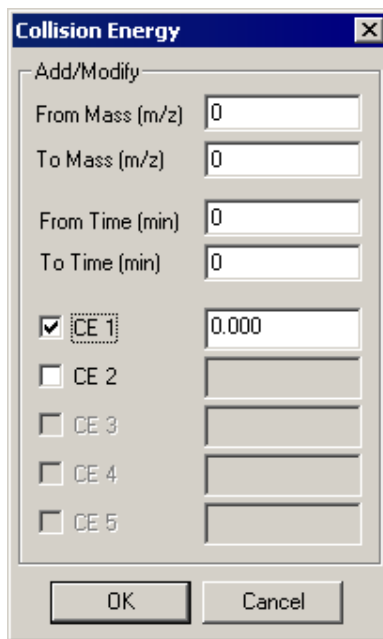

Figure 4-28 Collision Energy Dialog

From Mass (m/z)	Start mass for the mass range in which the Collision Energy Profile is to be used.
To Mass (m/z)	End mass for the mass range in which the Collision Energy Profile is to be used.
From Time (min)	Start time for the time range in which the Collision Energy Profile is to be used.
To Time (min)	End time for the time range in which the Collision Energy Profile is to be used.
CE 1, etc.	The five allowed collision energy values, which will be applied to a relevant mass at a relevant time during MSMS scanning. Selecting the check box for one value enables that for the following value.
OK	Select this button to close the Collision Energy dialog and enter the selected values in the CE Profile dialog Collision Energy Profile Table.

The Modify Charge State Dialog

The **Modify Charge State** dialog is invoked by the **Survey Scan** dialog, **Collision Energy** page, Charge State Recognition frame, **Modify** button. This allows the user to create a Mass List for the charge state recognition software.

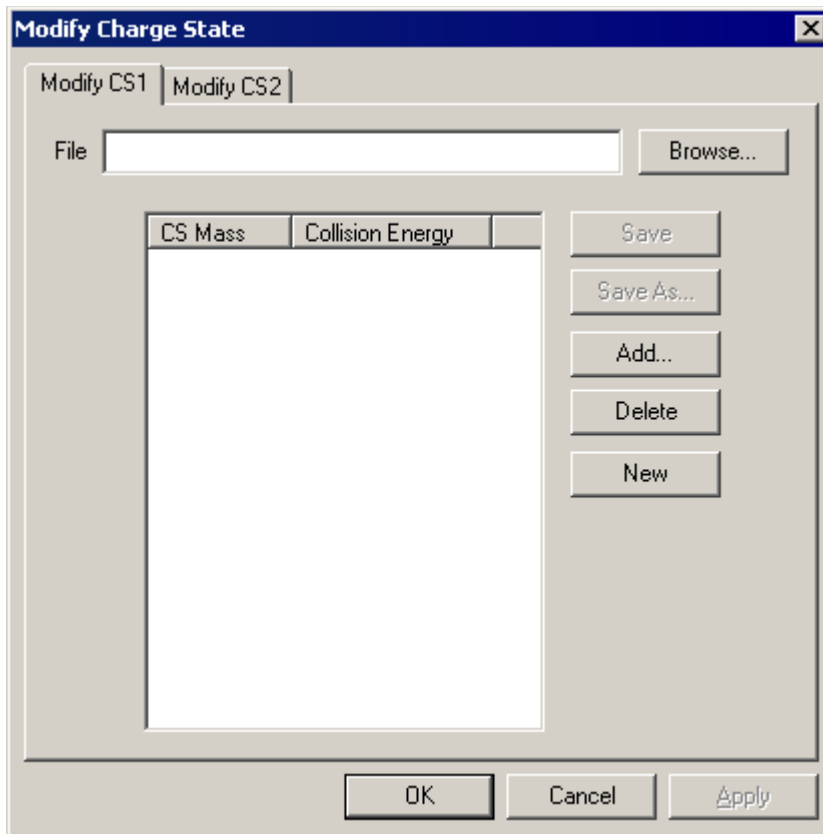

Figure 4-29 Modify Charge State Dialog

The **Modify Charge State** dialog will have one page for each **CSx File** currently-enabled in the **Survey Scan** dialog, **Collision Energy** page.

Selecting the **Add** button, or double-clicking on an entry in the Mass List invokes the **Charge State Mass** dialog; this allows the user to add new entries to the Mass List.

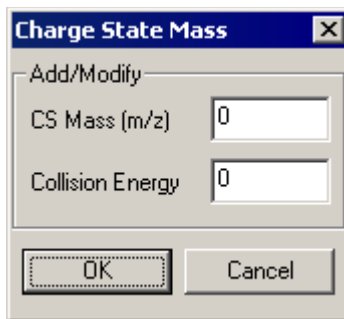

Figure 4-30 Charge State Mass Dialog

CS Mass (m/z)	The mass of interest.
Collision Energy	The correct collision energy value to break up the mass of interest.
OK	Select this button to close the Charge State Mass dialog and enter the selected values in the Modify Charge State dialog Mass List.

Charge State Recognition Functionality

The **Include** Page, **Include by Charge State** and the **Collision Energy** Page, **Use Charge State Recognition** functionalities can be used independently, or both can be configured to combine their individual functionalities.

Using Charge State Recognition with Include by Charge State disabled

This allows the software to switch on any peak of interest, but a collision energy value will only be calculated for those masses with a Charge State, which matches those set up in the **Charge State Recognition** section. For all other masses, the default collision energy will be applied; this is either the Tune Page value, or the value set up on the **Survey Scan** dialog **MSMS Template** Page.

For example:

- The Include by Charge State option is disabled.
- The Charge State Recognition has been configured for Charge States 1 and 2.

In this case, any mass of interest detected will be switched on in the normal way. Masses switched on with a Charge State of 1 or 2, will have a collision energy value calculated from the Charge State Recognition table. All other masses will use the specified default collision energy value.

Using Charge State Recognition with Include by Charge State enabled

This restricts the masses switched on to those with the correct Charge State. For those masses with a Charge State that is configured on both the **Include by Charge State** and **Charge State Recognition** sections, a collision energy value will be calculated. For masses with a Charge State, which is on the **Include by Charge State** list only, a default collision energy value will be used.

For example:

- The Include by Charge State section is configured to allow Charge States of 2 and 3.
- The Charge State Recognition section is configured for Charge States 1 and 2.

In this case, only masses with a Charge State of 2 or 3 will be switched on. Masses switched on with a Charge State of 2 will have a collision energy value calculated from the Charge State Recognition table. Masses with a Charge State of 3 will use the specified default collision energy value.

Survey Scan Dialog: Adduct Page

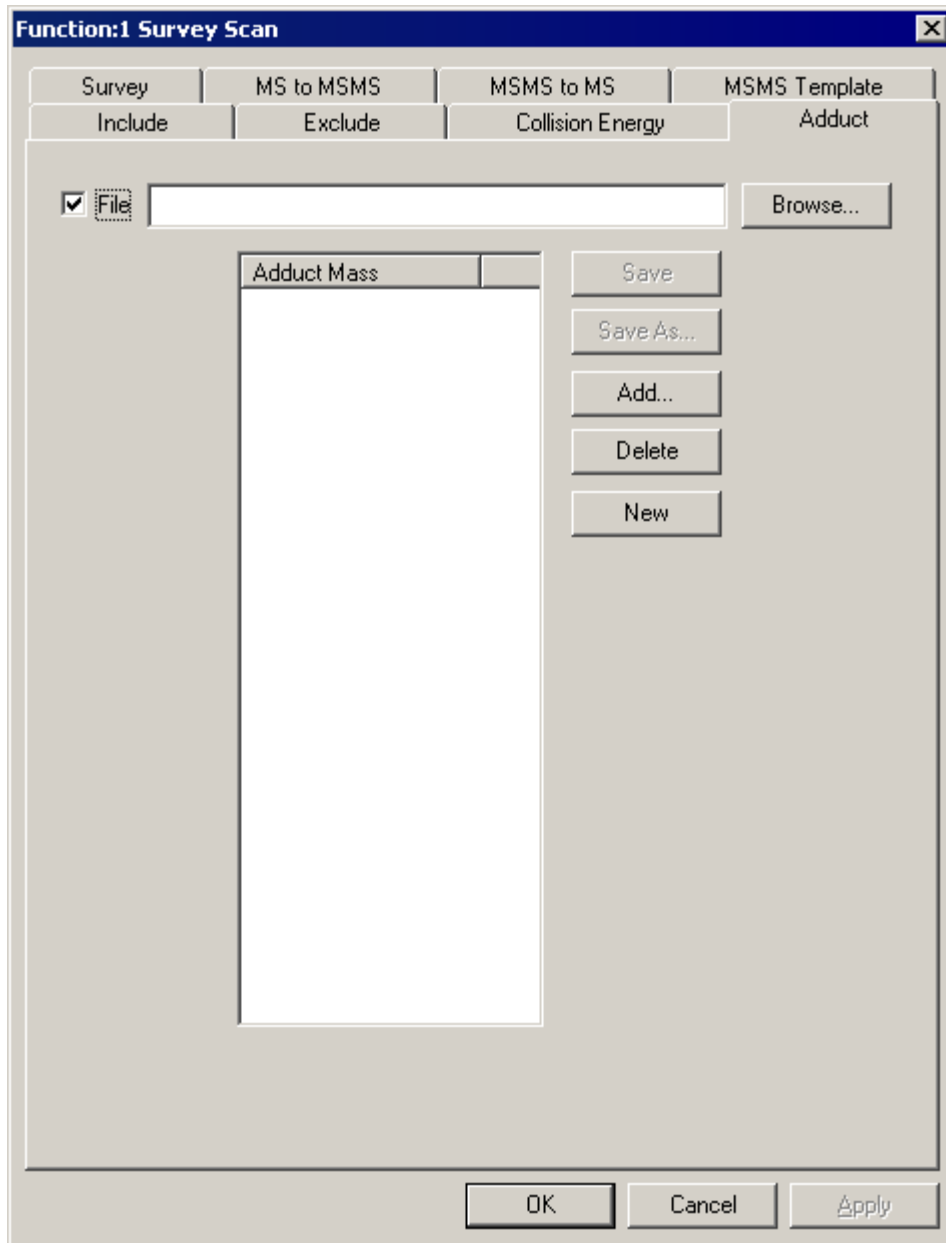

Figure 4-31 Survey Scan Dialog: Adduct Page

This page allows the user to set up an Adduct List; this is a list of masses that, if detected for switching, will have their Adduct masses added to the Exclude list.

An Adduct is a mass that has gained or lost a molecule.

When a mass of interest is found and an Adduct list exists, the function switching software will generate Adduct Masses on the Exclude list. This is to stop the Adducts of a mass being switched on in future MSMS scans.

Selecting the **Add** button, or double-clicking on a mass in the Adduct List, will invoke the **Adduct Mass** dialog.

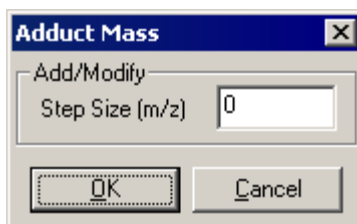

Figure 4-32 Adduct Mass Dialog

Enter the required value in the **Add/Modify, Step Size (m/z)** text box, then select the **OK** button to add the value to the Adduct List in the **Adduct Page**.

Monitoring Acquisitions

When an acquisition is started, the **Function Switching Status** dialog is invoked; this shows the currently running precursors.

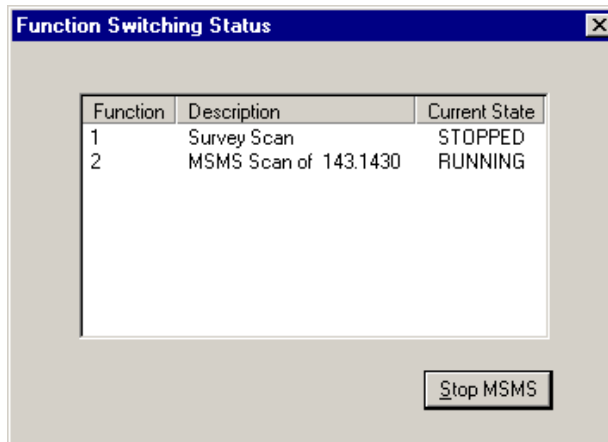

Figure 4-33 Function Switching Status

Chapter 5

Mass Calibration

5.1 Introduction

This chapter is divided into three sections:

- A brief general overview of the calibration process.
- A complete mass calibration of Quattro Ultima Pt using ElectroSpray ionization with a mixture of sodium iodide and rubidium iodide as the reference compound.
- A complete mass calibration of Quattro Ultima Pt using atmospheric pressure chemical ionization (APCI) with PEG as the reference compound.

See the *Reference Information* section for details of calibration solutions and their preparation.

5.2 Overview

MassLynx NT allows a fully automated mass calibration to be performed, which covers the instrument for static and scanning acquisition modes over a variety of mass ranges and scanning speeds.

A mass spectrum of a reference compound (a calibration file) is acquired and matched against a table of the expected masses of the peaks in the reference compound, which are stored as a reference file. The mass differences between the reference peaks and calibration peaks are the calibration points. A calibration curve is fitted through the calibration points.

The vertical distance of each calibration point from the curve is calculated. This distance represents the remaining (or residual) mass difference after calibration.

The standard deviation of the residuals is also calculated. This number is the best single indication of the accuracy of the calibration.

5.2.1 Calibration Types

Each quadrupole analyzer requires up to three calibration curves:

- A static calibration is used to ‘park’ the analyzer accurately on a specific mass of interest (in tuning and SIR for example).
- A scanning calibration enables peaks acquired in a scanning acquisition to be mass measured accurately.
- A scan speed compensation calibration compensates for ‘lag time’ in the system when the instrument is scanned rapidly.

A separate mass spectrum of the reference compound is acquired for each selected calibration type.

Quattro Ultima Pt requires these three calibrations for both MS1 and MS2, for a maximum of six calibration curves. The table below shows which types of calibration are necessary for particular types of experiment.

Experiment	Calibration Required	
	MS1	MS2
MS	All Static	
SIR		
MSMS		
MRM		

5.2.2 The Calibration Process

- Tuning the instrument.
- Selecting the appropriate reference file for the reference sample to be used.
- Starting an automatic calibration.
- Checking the calibration report.

5.3 ElectroSpray Calibration

5.3.3 Introduction

When a calibration is completed, it is possible to acquire data over any mass range within the calibrated range. It is therefore sensible to calibrate over a wide mass range.

With a mixture of sodium iodide and rubidium iodide, calibration over the full mass range of the instrument is achievable.

5.3.4 Preparing for Calibration

Reference Compound Introduction

The example given here describes an automatic calibration that requires reference compound to be present for several minutes. The introduction of the reference compound is best achieved using a large volume Rheodyne injector loop (50 or 100 μ l) or an infusion pump (for example, a Hamilton syringe pump).

When using a large volume injection loop:

Set up a solvent delivery system to deliver 4-5 μ l/min of 50:50 acetonitrile:water or 50:50 methanol:water through the injector into the source.

An injection of 50 μ l of reference solution lasts for at least 10 minutes.

When using an infusion pump:

Fill the syringe with the reference solution.

Couple the syringe to the ElectroSpray probe with fused silica tubing.

Set the pump to a flow rate of 4-5 μ l/min.

Tuning

Before beginning calibration, and with reference solution admitted into the source:

On the Tune Page, set **Multiplier** to 650 V.

Adjust the source parameters to optimize peak intensity and shape.

Set the resolution and ion energy parameters for unit mass resolution on **MS1** and **MS2**.

For a good peak distribution across the full mass range:

Check the intensity of some of the reference peaks above 1000 amu.

Check the intensity of the peak at m/z 173.

Ensure that no peaks are saturated. If necessary, reduce **Multiplier**.

A cone voltage in the region of 90 V is usually suitable.

Instrument Threshold Parameters

Before beginning the calibration procedure, certain instrument parameters must be checked.

For most low mass range calibrations, calibration data is acquired in continuum mode.

To allow suitable scanning speeds to be used the continuum data, parameters need to be set correctly:

Select the Tune Page Menu Bar **Options, Set Instrument Threshold** command; the **Instrument Threshold Settings** dialog is invoked.

The screenshot shows the 'Instrument Threshold Settings' dialog box. It is organized into several sections:

- Profile Data:** Baseline Level: 0; Points per Dalton: 16 (dropdown).
- Centroid Data:** Minimum centroid height: 1; Minimum points per peak: 10.
- SIR Data:** SIR Baseline Level: 0.
- Ion Counting:** Threshold: 0.
- Profile Data - Spike Removal:** Use Spike Removal: ; Minimum Spike Intensity: 0; Spike Percentage Ratio: 0.
- Analog Data:** Analog samples/sec: 4 (dropdown).

Buttons for 'OK' and 'Cancel' are located on the right side of the dialog.

Figure 5-1 Instrument Threshold Settings Dialog

Set the **Profile Data** frame **Points per Dalton** to **16**.

Select the **OK** button to save the parameters.

5.3.5 Calibration Options

To access the calibration options:

Select the Tune Page Menu Bar **Calibration**, **Calibrate Instrument** command; the **Calibration** dialog is invoked.

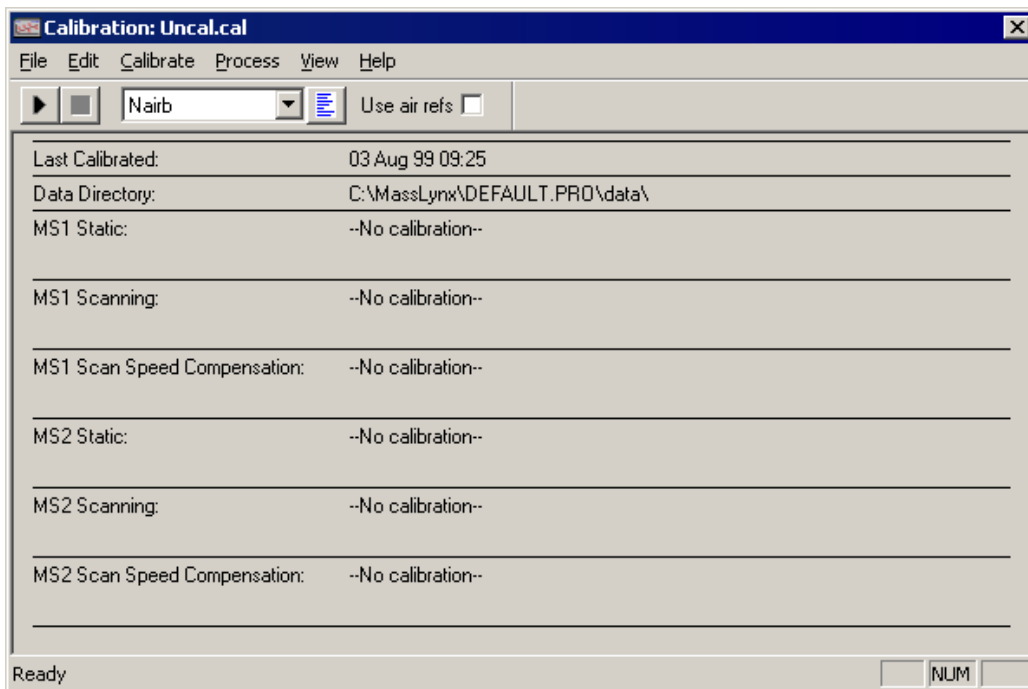

Figure 5-2 Calibration Dialog

Selecting the Reference File

Select the appropriate reference file from the list box at the top of the **Calibration** window.

Select **nairb.ref** for a sodium iodide and rubidium iodide reference solution.

Removing Current Calibrations

Select the **Calibration** dialog Menu Bar **File**, **Open** command; the **Open** dialog is invoked.

Select the **uncal.cal** calibration file.

Select the **OK** button; the **Open** dialog is closed.

This ensures that a file with no calibration is currently active on the instrument and prevents any previously saved calibrations from being modified or overwritten.

5.3.6 Selecting Parameters

Several parameters need to be set before a calibration is started. Default parameters are set when the software is initially loaded, which usually give a suitable calibration, but under some conditions, these may need to be adjusted.

Automatic Calibration Check

Select the Menu Bar **Edit, AutoCal Check Parameters** command; the **Automatic Calibration Check** dialog is invoked.

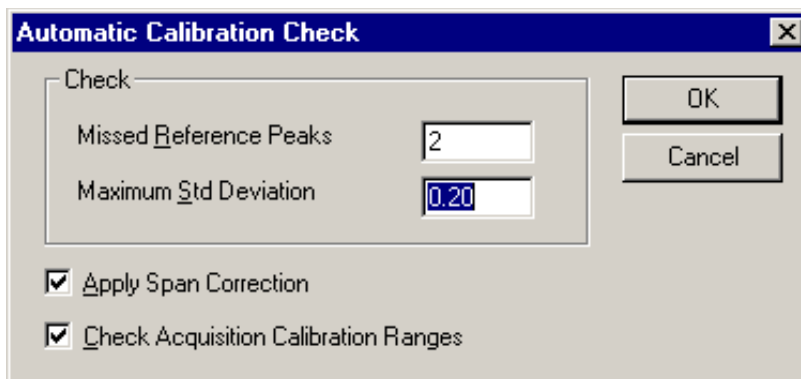

Figure 5-3 Automatic Calibration Check Dialog

This dialog is used to set limits that the calibration must attain before the instrument is successfully calibrated. Two user parameters can be set:

Missed Reference Peaks sets the maximum number of consecutive peaks that are not matched when comparing the reference spectrum and the acquired calibration spectrum. If this number is exceeded, the calibration fails. The default value for this parameter, 2, is suitable in most cases.

Maximum Std Deviation is set to a default of 0.20. During calibration, the difference between the measured mass in the acquired calibration file and the true mass in the reference file is taken for each pair of matched peaks. If the standard deviation of the set of mass differences exceeds the set value, the calibration fails. Reducing the value of the standard deviation gives a more stringent limit. Increasing the standard deviation means

that the requirement is easier to meet, but this may allow incorrect peak matching. Values greater than 0.20 should not be used unless exceptional conditions are found.

Apply Span Correction should always be selected. This allows different mass ranges to be scanned, within the calibrated range, without affecting mass assignment.

Check Acquisition Calibration Ranges causes warning messages to be displayed if an attempt is made to acquire data outside the calibrated range for mass and scan speed. It is advisable to leave selected.

Calibration Parameters

Select the Menu Bar **Edit, Calibration Parameters** command; the **Calibration Parameters** dialog is invoked.

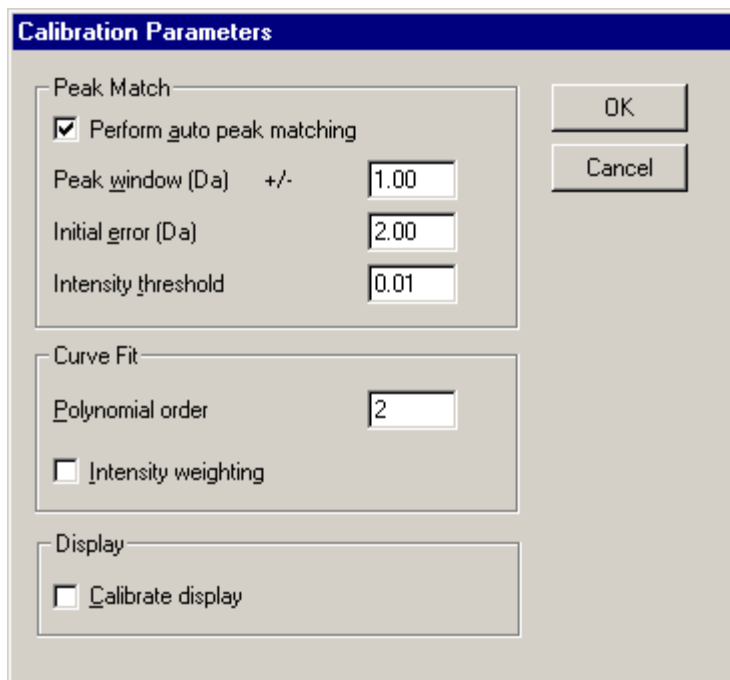

Figure 5-4 Calibration Parameters Dialog

The **Peak Match** parameters determine the limits within which the acquired data must lie for the software to recognize the calibration masses and result in a successful calibration. The default values are shown.

Increasing **Peak window (Da)** and **Initial error (Da)** gives a greater chance of incorrect peak matching. All peaks in the acquired spectrum lying below the **Intensity threshold**

value (measured as a percentage of the most intense peak in the spectrum) are not used in the calibration procedure.

The **Polynomial order** of the curve has values from 1 to 5 as the available options:

A polynomial order of 1 should not be used.

An order of 2 is suitable for wide mass ranges at the high end of the mass scale, and for calibrating with widely spaced reference peaks. Sodium iodide in particular has widely spaced peaks (150 amu apart), and horse heart myoglobin is used to calibrate higher up the mass scale, so this is the recommended polynomial order for these calibrations.

An order of 3 fits a cubic curve to the calibration.

A fourth order is used for calibrations that include the lower end of the mass scale, with closely spaced reference peaks. This is suitable for calibrations with PEG that extend below 300 amu.

A fifth order fit rarely has any benefit over a fourth order fit.

Mass Measure Parameters

Select the Menu Bar **Edit, Quad Mass Measure Parameters** command; the **Mass Measure** dialog is invoked.

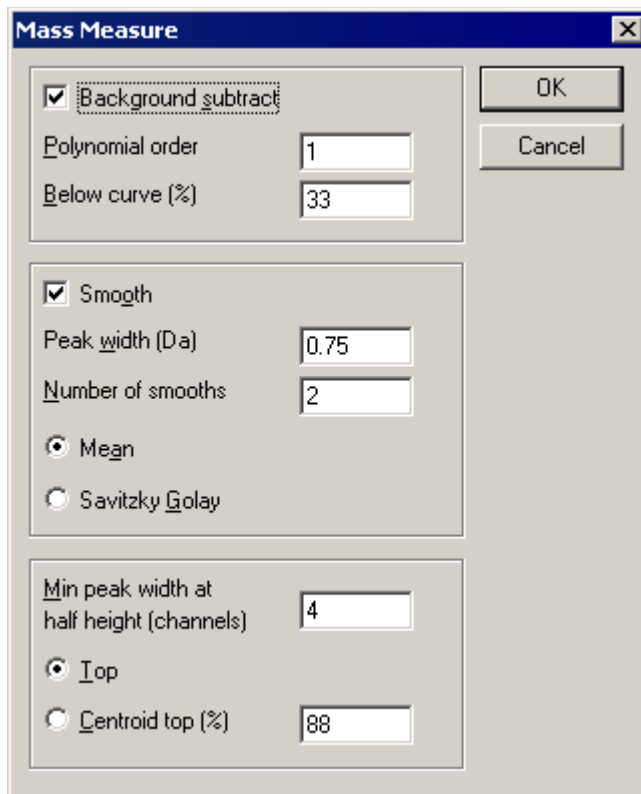

Figure 5-5 Mass Measure Dialog

If continuum or MCA data are acquired for calibration, these parameters need to be set before the calibration is carried out. If centroided data are used for calibration, the mass measure parameters are not used.

With ElectroSpray calibrations, particularly with sodium iodide that has some low intensity peaks at higher mass, it is recommended that continuum or MCA data are acquired.

At high scan speeds, instrument resolution may decrease. Ensure that the centroiding parameters are set to use the top 80% (or lower, if appropriate) of the peak. Use **Centroid top (%)**, not **Top**.

5.3.7 Performing a Calibration

Select the **Calibrate** window Menu Bar **Calibrate**, **Start Acquisition** command, or the  button; the **Automatic Calibration** dialog is invoked.

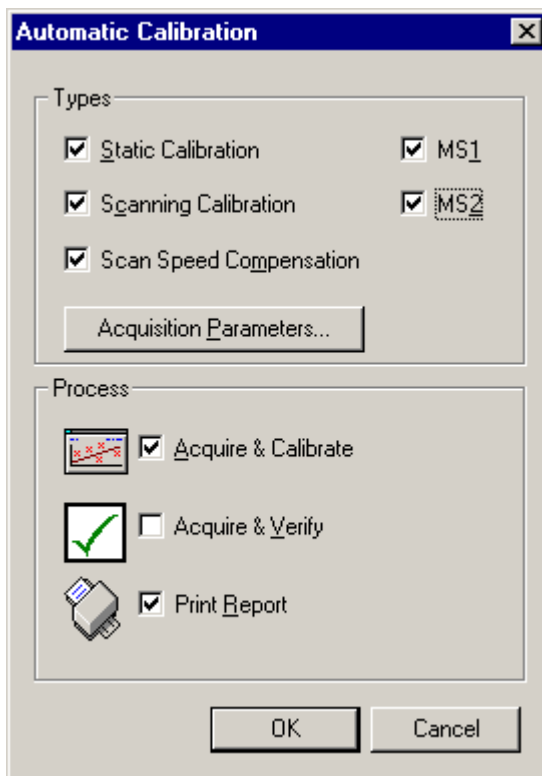

Figure 5-6 Automatic Calibration Dialog

Three types of calibration can be selected in this dialog: **Static Calibration**, **Scanning Calibration** and **Scan Speed Compensation**.

It is recommended that all three types of calibration are performed, so that any mode of data acquisition can be used and mass ranges and scan speeds can be changed whilst maintaining correct mass assignment. However, it is possible to have any combination of these calibrations:

- If only a **Static Calibration** is present, the instrument is calibrated for acquisitions where the quadrupoles are held at a single mass, as in SIR or MRM.
- If only a **Scanning Calibration** is present, the instrument is only correctly calibrated for scanning acquisitions over the same mass range, and at the same scan speed, as those used for the calibration.
- If only a **Scan Speed Compensation** is present (with no **Scanning Calibration** having been performed), the **Scan Speed Compensation** is treated as a **Scanning Calibration**. Hence, the instrument is only correctly calibrated for scanning acquisitions over the same mass range and at the same scan speed as used for the calibration.

For the **Scan Speed Compensation** to be used correctly, a **Scanning Calibration** should also be performed.

- If **Static Calibration** and **Scanning Calibration** are both present, the instrument is calibrated for acquisitions where the quadrupole is held at a single mass. It is also calibrated for scanning acquisitions with a mass range that lies within the mass range of the **Scanning Calibration**, providing that the same scan speed is used.

For example, if the instrument is calibrated from m/z 100 to 900 with a 2 s scan (at 400 amu/s), data can be acquired from 100 - 500 amu with a 1 s scan time (also at 400 amu/sec) whilst maintaining correct mass assignment. In this case, the **Static Calibration** would be used to determine the start mass of the acquisition, and the **Scanning Calibration** would be used for mass assignment and scan range.

- If **Scanning Calibration** and **Scan Speed Compensation** are present, the instrument is only calibrated for scanning acquisitions over the same mass range as that used for the calibration. However, the scan speed can be changed, if it remains within the scan speeds used for the two calibrations. The mass range should not be changed, as there is no static calibration to locate the start mass.
- If all three types of calibration are present, all types of acquisition can be used providing that the mass range and scan speed are between the lower and upper limits used for the scanning calibration and the scan speed compensation.

For a complete calibration:

In the **Types** frame, select the **Static Calibration**, **Scanning Calibration** and **Scan Speed Compensation** options.

Select the **MS1** and **MS2** options.

In the **Process** frame, select the **Acquire & Calibrate** and **Print Report** options.

Acquisition Parameters

Selecting the **Automatic Calibration** dialog **Acquisition Parameters** button invokes the **Calibration Acquisition Setup** dialog, where the mass ranges, scan speeds and acquisition mode are selected. When this box is first invoked, it contains default parameters relevant to the chosen reference file. These default parameters show the limits of scan range and scan speed for the currently selected instrument and calibration parameters.

Acquisition Parameters		
Scan From	50	amu
Scan To	3920	amu
Run Duration	1	mins
Data Type	Continuum	

Scan Parameters		
Static Span ±	4	amu
Static Dwell	0.1	sec
Slow Scan Time	40	sec
Fast Scan Time	3	sec
Inter Scan Delay	0.1	sec

Figure 5-7 Calibration Acquisition Setup Dialog

The **Acquisition Parameters** frame is used to select the mass range, run time and data type.

When the instrument is fully calibrated, any mass range or scan speed is allowed, within the upper and lower limits dictated by the calibrations.

If the **nairb.ref** file is selected, selecting the **Default** button gives the parameters shown above. The solution described in the *Reference Information* section is suitable for use with this reference file.

If compatible reference solutions and reference files are used, simply selecting the **Default** button is sufficient; no parameters need be entered manually.

Run Duration sets the time spent acquiring data for each part of the calibration. The time set must allow a minimum of three scans to be acquired at the slowest scan speed used. If the run duration is too short, data are not acquired. The slowest scan speed generally used is 100 amu/s. With **Scan From** set to 20 amu and **Scan To** set to 2000 amu, a scan time of 19.8 s is required, and an **Inter Scan Delay** (in the **Scan Parameters** frame) of 0.1 s is usually used. Therefore, the run duration must be greater than 59.6 s (three scans + two inter scan delays). A **Run Duration** of 1.00 minutes is suitable.

The lower frame in the **Calibration Acquisition Setup** dialog box contains the **Scan Parameters**.

When an instrument acquires data for a static calibration, it examines the reference file to find the expected reference masses, and then acquires data over a small mass span around each peak's expected position. Thus, the acquired data do not contain continuous scans. Each spectrum comprises small regions of acquired data around each peak, separated by regions where no data are acquired.

Static Span \pm sets the size of this small region around each reference peak. A span of 4.0 amu is typical.

Static Dwell determines how much time is spent acquiring data across the span. A value of 0.1 second is suitable.

Slow Scan Time determines the scan speed used for the scanning calibration. If both a **Scanning Calibration** and a **Scan Speed Compensation** are to be performed, the scan speed should be set to approximately 100 amu/s (a scan time of 19.8 s over a mass range of 20 to 2000 amu). If only a **Scanning Calibration** is to be performed (without **Scan Speed Compensation**) then the scan speed should be set at the same speed to be used for later acquisitions.

Fast Scan Time determines the scan speed used for the scan speed compensation, and the upper limit of scan speed that can be used for subsequent acquisitions.

Select the **Default**, then **OK** buttons to return to the **Automatic Calibration** dialog box. Alternatively, select chosen values if a different calibration range is required.

Starting the Calibration Process

To start the calibration process:

Select the **Automatic Calibration** dialog **OK** button.

The instrument acquires all of the calibration files in the following order using the data file names shown:

MS1 static calibration data file: STATMS1
MS1 scanning calibration data file: SCNMS1
MS1 scan speed compensation data file: FASTMS1
MS2 static calibration data file: STATMS2
MS2 scanning calibration data file: SCNMS2
MS2 scan speed compensation data file: FASTMS2

Once all of the data have been acquired, each data file is combined to give a single spectrum that is then compared against the reference spectrum to form a calibration. This process takes place in the same order as above. If the full calibration dialog box is open, a constantly updated status message for the calibration is displayed.

If, when the process is completed, the calibration statistics meet with the requirements specified by the selected calibration parameters, a successful calibration message is displayed. A calibration report is then printed showing a calibration curve for each of the calibration processes. An example of a calibration report is shown on the following page.

Mass 18 Da to 3925 Da. Res=14.5/14.5 IE=0.5

Calibrated - 15:12 on 11/27/97

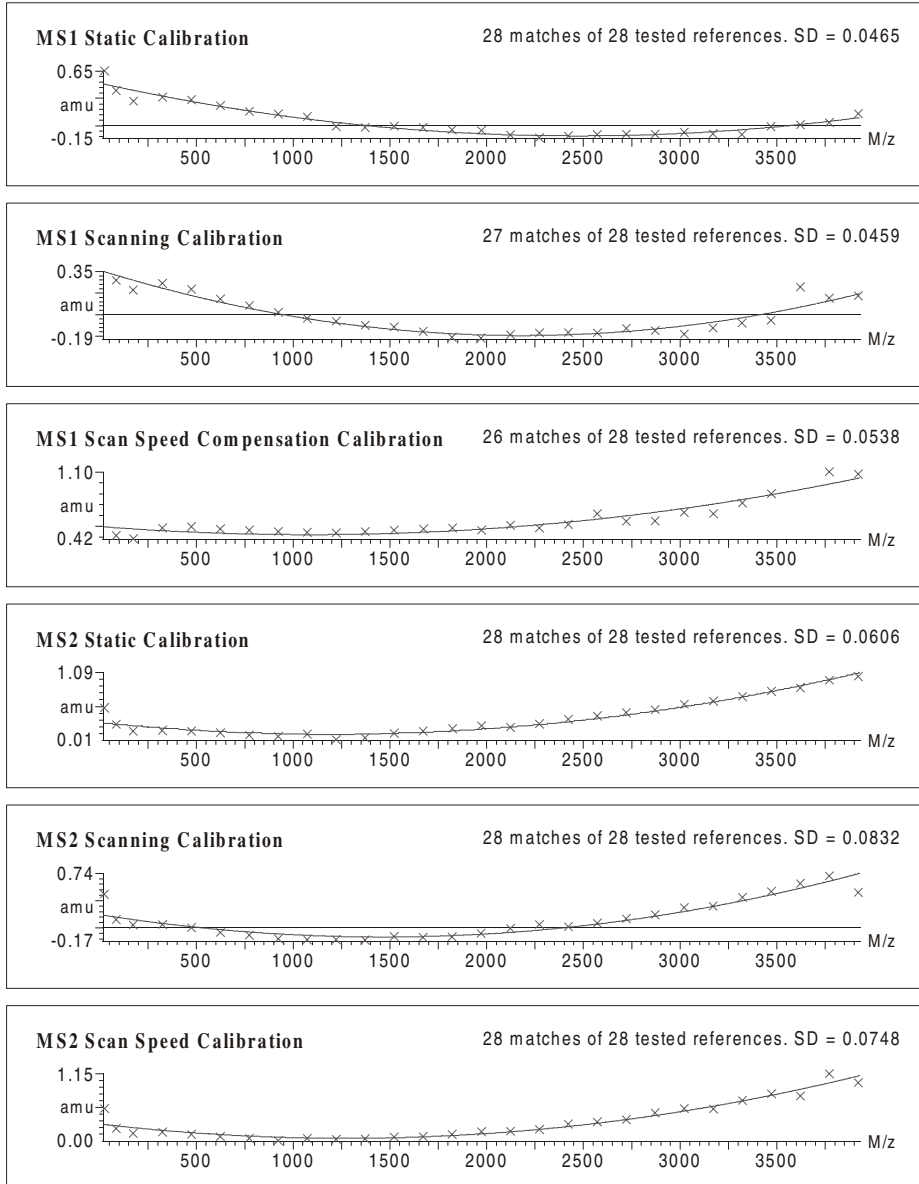

Figure 5-8 Calibration Report Example

5.3.8 Checking the Calibration

The calibration (successful or failed) can be viewed in more detail by selecting the **Calibrate** window Menu Bar **Process, Verification From File** command; the **Display Verification Graphs** dialog is invoked. This allows the choice of calibration type for viewing. With the required calibration selected, the correct calibration file is automatically opened.

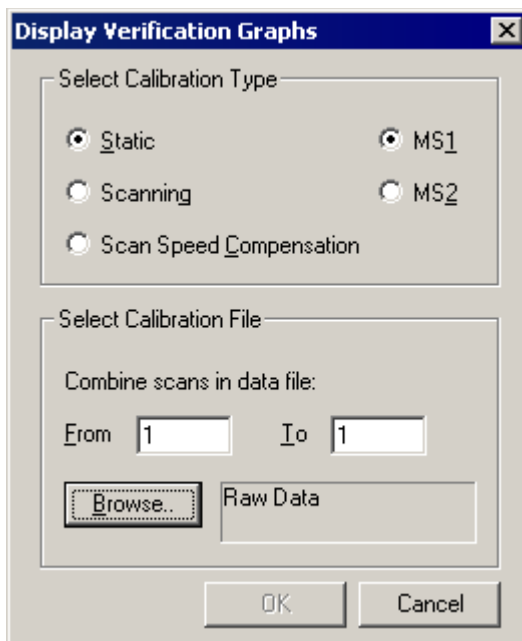

Figure 5-9 Display Verification Graphs Dialog

Select the **Browse** button to select the calibration data file (for example STATMS1, SCNMS1, FASTMS!, STATMS2, etc.).

Selecting the **OK** button repeats the calibration procedure for that particular file and displays a calibration report on the screen. This calibration report (following page upper) contains four displays:

- The acquired spectrum.
- The reference spectrum.
- A plot of mass difference against mass (the calibration curve).
- A plot of residual against mass.

An expanded region can be displayed (following page lower) by clicking and dragging with the left mouse button. In this way, the less intense peaks in the spectrum can be examined to check that the correct peaks have been matched. The peaks in the acquired spectrum, which have been matched with a peak in the reference spectrum, are highlighted in a different color.

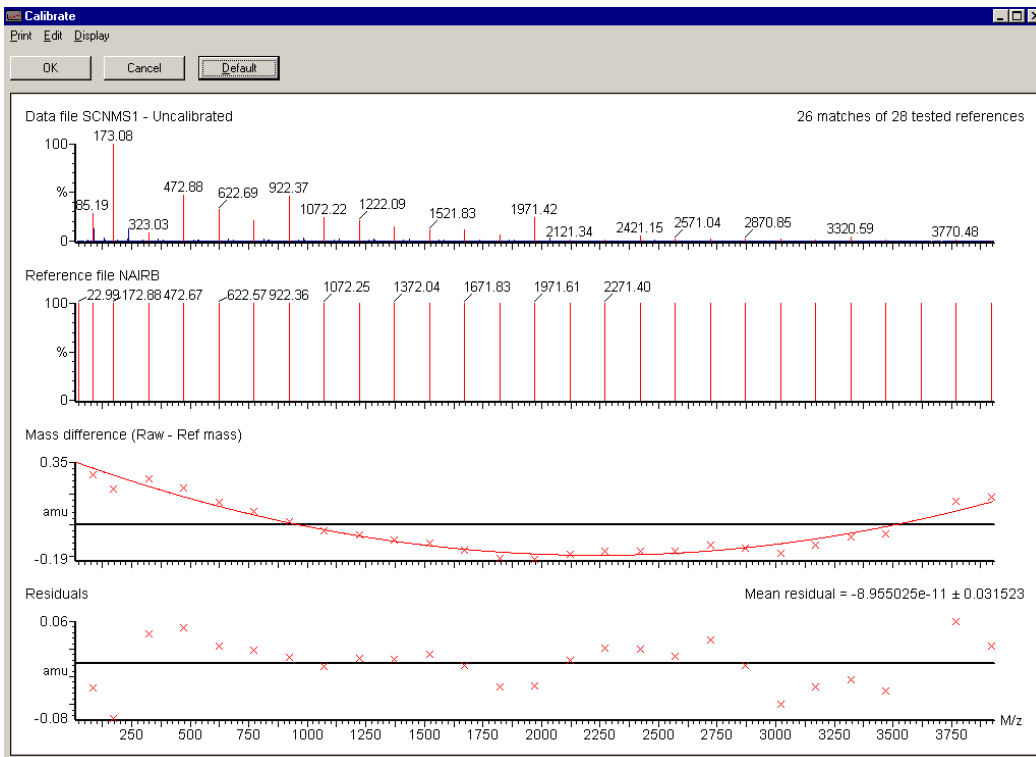

Figure 5-10 Calibration Report Display

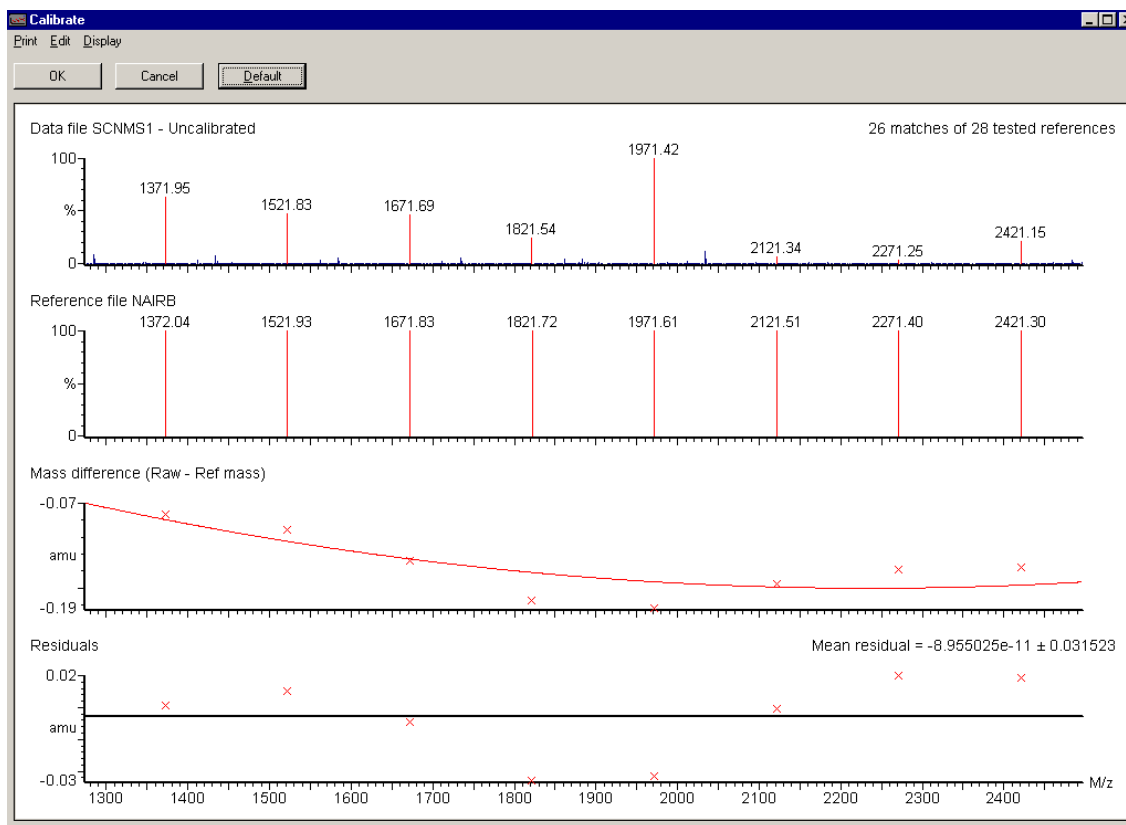
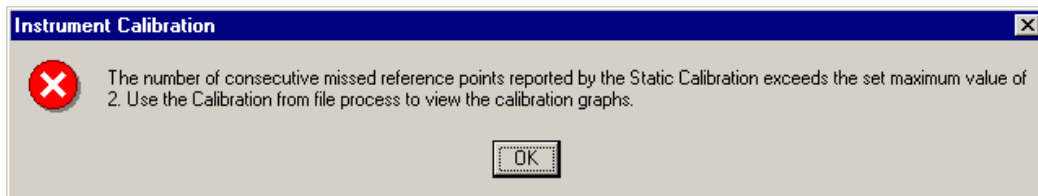

Figure 5-11 Calibration Report - Peak Matching

Calibration Failure

If the calibration statistics do not meet the requirements, a message is displayed describing at what point, and why, the calibration failed. This message also states where the attempted calibration data can be viewed, so that the exact cause of failure can be determined.



There are several reasons why a calibration may fail:

- No peaks. If the acquired calibration data file contains no peaks, the calibration fails. This may be due to:

Lack of reference compound.

No flow of solvent into the source.

Multiplier set too low.

- Too many consecutive peaks missed. If the number of consecutive peaks that are not found exceeds the **Missed Reference Peaks** parameter set in the **Automatic Calibration Check** dialog (see the Automatic Calibration Check section), the calibration fails. Peaks may be missed for the following reasons:

The reference solution is running out, hence the less intense peaks are not detected.

Multiplier is too low so that the less intense peaks are not detected.

An incorrect ionization mode is selected. Check that the data have been acquired with **Ion Mode** set to **ES+**.

Intensity threshold, set in the **Calibration Parameters** dialog (see the *Calibration Parameters* section), is too high. Peaks are present in the acquired calibration file but are ignored because they are below the threshold level. *Note that it is possible to calibrate in negative ion mode ElectroSpray using the naineg.ref reference file with a suitable reference solution.*

Either **Initial error** or **Peak window**, set in the **Calibration Parameters** dialog, is too small. The calibration peaks lie outside the limits set by these parameters.

Maximum Std Deviation, set in the **Automatic Calibration Check** dialog, has been exceeded.

The wrong reference file has been selected. Check that the correct file (nairb.ref in this case) is selected in the **Calibrate** window.

In the case of too many consecutive peaks missed:

Check the data in the on-screen calibration report to see if the missed peaks are present in the acquired calibration file.

If the peaks are not present then the first three reasons above are likely causes.

If the peaks are present in the data but are not recognized during calibration then the latter four are likely reasons.

Having taken the necessary action, proceed as follows:

If the **Calibration Parameters** dialog **Intensity threshold**, **Initial error** and **Peak window** options are adjusted to obtain a successful calibration, check the on-screen calibration report to ensure that the correct peaks have been matched.

*With a very low threshold and wide ranges set for the **Initial error** and **Peak window**, it may be possible to select the wrong peaks and get a “successful” calibration. This is particularly relevant for calibrations with PEG where there may be peaks due to $PEG+H^+$, $PEG+NH_4^+$, $PEG+Na^+$, and also doubly charged species.*

Select **OK** from the calibration report window to accept the new calibration, or select **Cancel** to retain the previous calibration.

Incorrect Calibration

If the suggested calibration parameters are used and, providing that good calibration data have been acquired, the instrument should be calibrated correctly. However, in some circumstances it is possible to meet the calibration criteria without matching the correct peaks. This situation is unusual, but it is always sensible to examine the on-screen calibration report to check that the correct peaks have been matched. These errors may occur when the following parameters are set:

- **Intensity threshold** set to 0.
- **Initial error** too high (>2.0).
- **Peak window** too high (>1.5).
- **Maximum Std Deviation** too high (>0.2).

If the acquired spectrum looks like the reference spectrum, and all of the expected peaks are highlighted, the calibration is OK.

An alternative cause of incorrect calibration is from contamination or background peaks. If a contamination or background peak lies within one of the peak matching windows, and is more intense than the reference peak in that window, then the wrong peak is selected. Under some conditions, this may happen with PEG. There are two ways to counter this:

- If the reference peak is closer to the center of the peak window, then the peak window can be narrowed until the contamination peak is excluded. Take care to ensure that no other reference peak is excluded.
- If the reference peak is not closer to the center of the peak window, or if by reducing the window, other reference peaks are excluded, then the calibration can be edited manually.

Manual Editing of Peak Matching

If an incorrect peak has been matched in the calibration process, this peak can be excluded manually from within the on-screen calibration report.

Using the mouse, right-click over the peak in the acquired spectrum.

The peak is excluded and is no longer highlighted.

If the true reference peak is present then this can be included in the calibration by the same procedure.

Place the cursor right-click over the required peak .

The peak is matched with the closest peak in the reference spectrum.

Manually editing one peak does not affect the other matched peaks in the calibration.

Saving the Calibration

When the instrument is fully calibrated, the calibration can be saved under a file name so that it can be recalled for future use.

The recalled calibration has the same constraints of mass range and scan speed. The ion energy and resolution settings used for the calibration acquisition are also recorded as these can have an effect on mass assignment.

Verification

Once a full instrument calibration is in place, it is not always necessary to repeat the full calibration procedure when the instrument is next used. Instead calibration verification can be performed. (There is no benefit in verifying each calibration individually; re-calibration is just as quick.)

If a scanning acquisition is to be made and the calibration is to be checked:

Set up the instrument and access the **Calibrate** dialog as though a full calibration is to be carried out.

Set all the peak matching parameters to the values that were used for the calibration.

Select the **Calibrate** window Menu Bar **Calibrate, Start Acquisition** command, or the  button; the **Automatic Calibration** dialog is invoked.

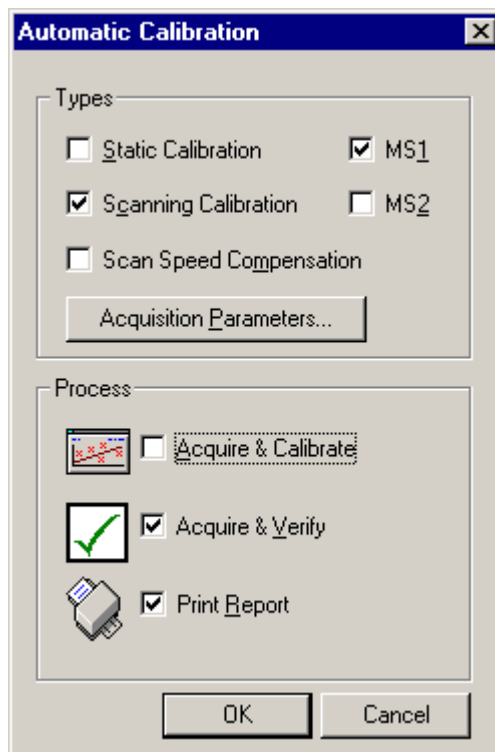

Figure 5-12 Automatic Calibration Dialog

Select the **Scanning Calibration** option.

Deselect the **Static Calibration** and **Scan Speed Compensation** options.

Deselect the **Acquire & Calibrate** option.

Select the **Acquire & Verify** and **Print Report** options.

Select either **MS1** or **MS2**, depending on the type of acquisition to be performed.

Select the **Acquisition Parameters** button; the **Calibration Acquisition Setup** dialog is invoked.

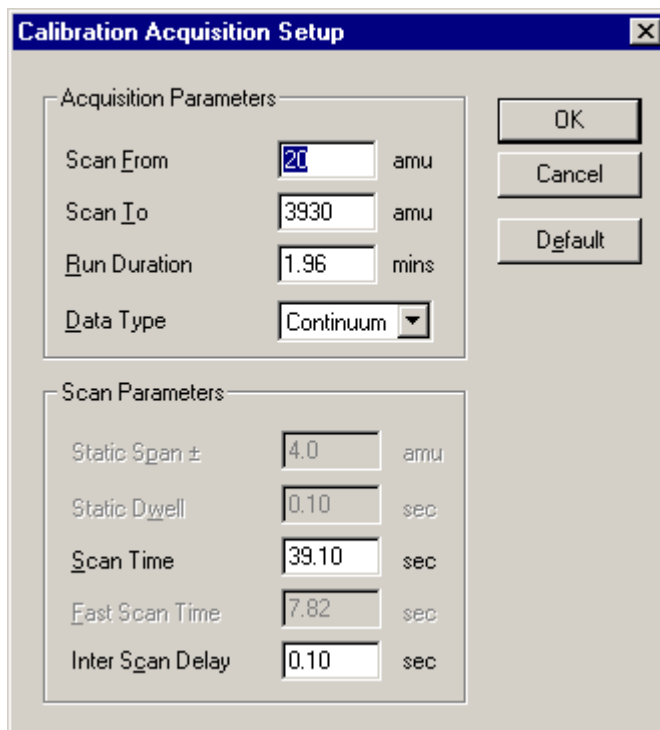

Figure 5-13 Calibration Acquisition Setup Dialog

The parameters entered should be identical to the parameters originally used for the calibration being verified.

Set **Scan From**, **Scan To**, **Run Duration**, **Data Type**, **Scan Time** and **Inter Scan Delay** to agree with the acquisition parameters that are to be used for data acquisition.

*With only the **Automatic Calibration** dialog **Scanning Calibration** option selected, all of the other options in this dialog box are unavailable.*

Select the **OK** button to return to the **Automatic Calibration** dialog and **OK** again to start the verification procedure.

A scanning acquisition is now performed. When the acquisition is complete, the data are combined to give a single spectrum, which is compared against the reference file. A

calibration curve is drawn and a report printed in a similar way to when the original calibration was performed. An example is shown below.

Unlike the original calibration procedure, the instrument calibration is not changed, and the report that is printed is a verification report.

Instrument Calibration Report.

Page 1

Mass 20 Da to 3930 Da. Res=14.5/14.5. IE=0.5

Calibrated - 15:12 on 11/27/97

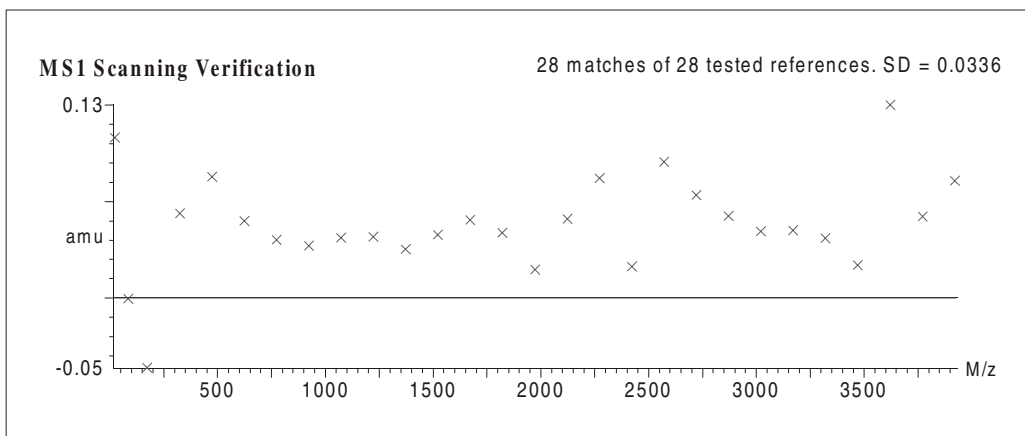

Figure 5-14 Calibration Verification Report

5.3.9 ElectroSpray Calibration with PEG

Caution should be used when calibrating with PEG in ElectroSpray mode due to the number of peaks that are produced. Although ammonium acetate is added to the PEG reference solution to produce $[M+NH_4]^+$ ions, under some conditions it is quite usual to see $[M+H]^+$, $[M+Na]^+$ and doubly charged ions.

The spectrum shown below demonstrates how the PEG spectrum can be dominated by doubly-charged ions (in this case $[M+2NH_4]^{2+}$) if the wrong conditions are chosen. In this case, the concentration of ammonium acetate in the reference solution is too high (5 mmol ammonium acetate is the maximum that should be used) and the **Cone** voltage is too low.

A low **Cone** voltage encourages the production of doubly charged ions. The voltage should be at least 120 V.

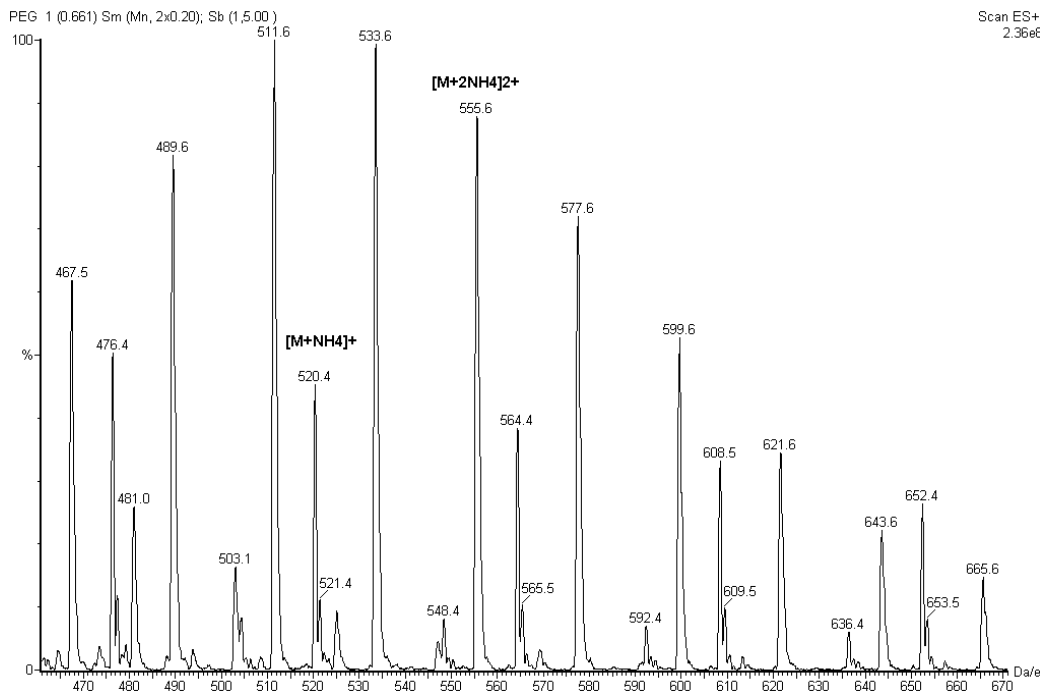

Figure 5-15 PEG Spectrum showing Excess of Doubly Charged Ions

Doubly charged peaks can be identified, because the ^{13}C isotope peak is separated from the ^{12}C isotope by only 0.5 Da/e. If the instrument is set to unit mass, and data are acquired in continuum mode, the doubly-charged peaks appear broader, as the isotopes are not resolved.

5.4 Atmospheric Pressure Chemical Ionization Calibration

5.4.1 Introduction

This section describes a complete mass calibration of Quattro Ultima Pt using Atmospheric Pressure Chemical Ionization (APCI). The procedures described should be followed only after reading the previous sections in this manual, describing the automated calibration with ElectroSpray ionization.

Due to the high flow rates used with APcI, the residence time of an injection of reference solution in the source is too short to allow a fully automated calibration; the procedure, therefore, has to be carried out in several steps.

The recommended reference compound for APcI is a solution of polyethylene glycol (PEG) containing ammonium acetate. See the *Reference Information* section for advice on preparing the reference solution. See the following illustration for a typical PEG + NH₄⁺ spectrum.

With PEG, the possible calibration range is dependent upon the molecular weight distribution of the PEGs used in the reference solution. For this example, PEG grades from PEG 200 to PEG 1000 are used.

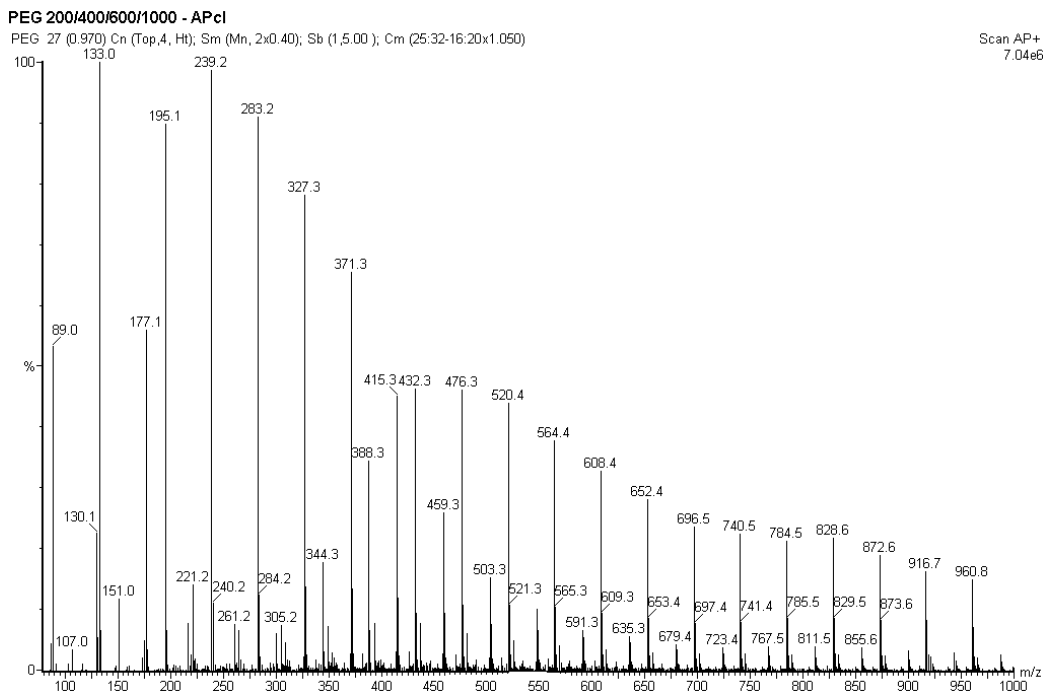

Figure 5-16 PEG 200 to PEG 1000 Spectrum

5.4.2 Preparing for Calibration

Reference Compound Introduction

It is best to use a large volume injection loop (50 μ l) with a solvent delivery system set up to deliver 0.2 ml/min of 50:50 acetonitrile:water or methanol:water through the injector and into the APcI source. An injection of 50 μ l of reference solution lasts for approximately 15 s, allowing enough time to perform a slow scanning calibration.

Tuning

Before beginning calibration:

Set **Multiplier** to 650 V.

Adjust source and lens parameters to optimize peak intensity and shape.

Set the resolution and ion energy parameters for unit mass resolution on **MS1** and **MS2**.

When a full calibration is completed, it is possible to acquire data over any mass range within the calibrated range. It is therefore sensible to calibrate over a wide mass range and in this example the calibration covers up to 1000 amu.

5.4.3 Calibration Options

To access the calibration options:

Select the Tune Page Menu Bar **Calibration, Calibrate Instrument** command; the **Calibration** window is invoked.

Selecting the Reference File

Select **pegh1000.ref** as the reference file from the list box at the top of the **Calibration** window.

Leave the **Use Air Refs** box blank when calibrating in APcI.

Removing Current Calibrations

Select the **Calibration** dialog Menu Bar **File, Open** command; the **Open** dialog is invoked.

Select the **uncal.cal** calibration file.

Select the **OK** button; the **Open** dialog is closed.

This ensures that a file with no calibration is currently active on the instrument and prevents any previously saved calibrations from being modified or overwritten.

5.4.4 Selecting Calibration Parameters

Several parameters need to be set before a calibration is started. Most of these parameters can be set at the same value as for ElectroSpray. However, in the **Calibration Parameters** dialog, a **Polynomial order** of 2 is recommended for the calibration **Curve Fit**.

5.4.5 Performing a Calibration

The three types of calibration (static, scanning and scan speed) must be carried out in single steps.

Static Calibration

Select the **Calibrate** window Menu Bar **Calibrate, Start Acquisition** command, or the  button; the **Automatic Calibration** dialog is invoked.

In the **Types** frame, select the **Static Calibration** and **MS1** options.

In the **Process** frame, select the **Acquire & Calibrate** option.

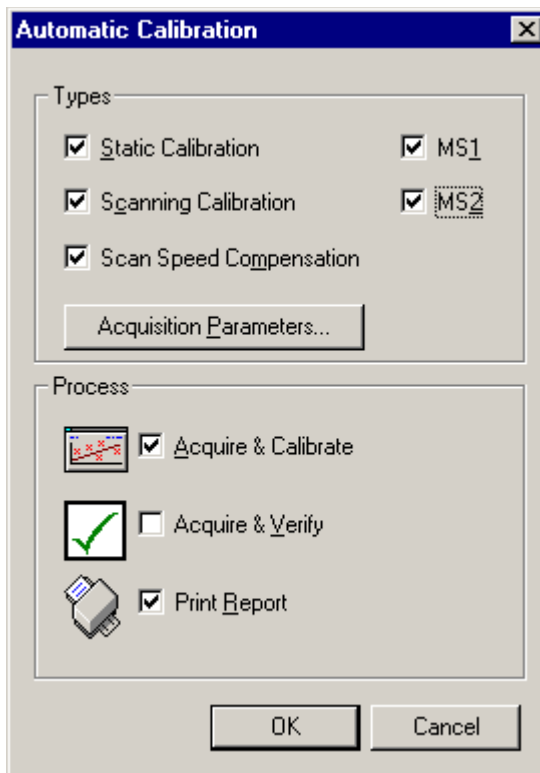

Figure 5-17 Automatic Calibration Dialog

Acquisition Parameters

Select the **Automatic Calibration** dialog **Acquisition Parameters** button; the **Calibration Acquisition Setup** dialog is invoked. This contains the default mass ranges, scan speeds and acquisition mode relevant to the peph1000.ref reference file.

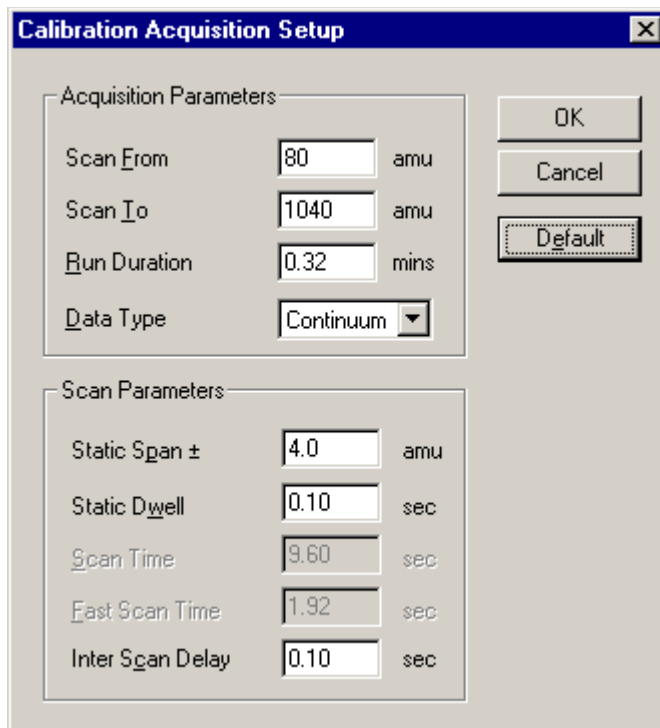

Figure 5-18 Calibration Acquisition Setup Dialog

The **Acquisition Parameters** frame is used to select the mass range, run time and data type.

When the instrument is fully calibrated, any mass range or scan speed is allowed within the upper and lower limits dictated by the calibrations. It is therefore sensible to calibrate over a wide mass range. Since the pegr1000.ref reference file has peaks from m/z 63 to m/z 987, it is possible to calibrate over this mass range which is sufficient for the majority of applications with APcI. The following example shows a set-up to achieve this.

Run Duration sets the time spent acquiring data for the static calibration. The time set must allow chance to inject a volume of reference solution and acquire several scans.

Data Type allows a choice of centroided, continuum or MCA data to be acquired. For APcI, while either continuum or centroided data may be used, **Continuum** is recommended.

The lower frame in the **Calibration Acquisition Setup** dialog contains the **Scan Parameters**.

When an instrument acquires data for a static calibration, it first examines the selected reference file for the expected reference masses. It then acquires data over a small mass span around the expected position of each peak. Thus the acquired data do not contain continuous scans, but each “spectrum” is made up of small regions of acquired data around each peak separated by blank regions where no data are acquired.

Static Span \pm sets the size of this small region around each reference peak. A value of 4.0 amu is typical.

Static Dwell determines how much time is spent acquiring data across the span. A value of 0.1 s is suitable.

Slow Scan Time and **Fast Scan Time** are not available when a static calibration alone is selected.

Select the **OK** button to return to the **Automatic Calibration** dialog box.

Acquiring Data

To start the calibration process:

Select the **Automatic Calibration** dialog **OK** button.

The instrument acquires a calibration file ready for static calibration using the data file name STAT. While data are being acquired:

Inject the reference solution.

Once the data have been acquired, the instrument attempts to produce a static calibration automatically. The data file contains only a few scans of the reference compound, the remaining scans being of background.

As the automatic calibration procedure combines all of the scans in the data file to produce a calibration spectrum, the resulting spectrum may be too weak to give a successful calibration. Whether the calibration is successful or failed, it is wise to check the calibration manually.

Manual Calibration

To perform a manual calibration:

Select the Tune Page Menu Bar **Calibrate**, **Calibrate Instrument** command; the **Calibration** dialog is invoked.

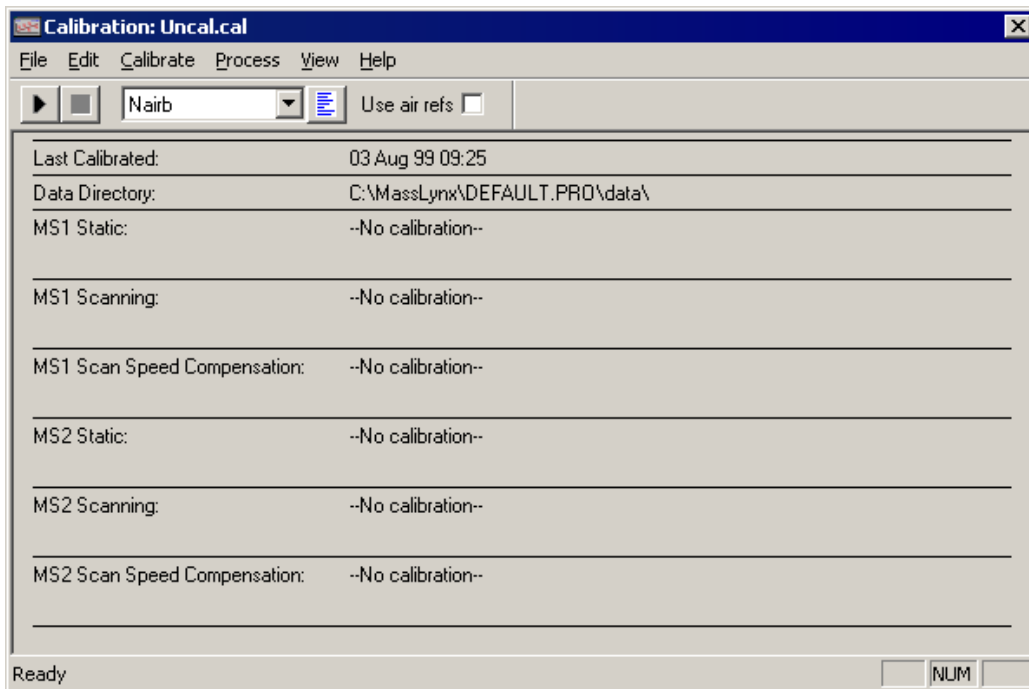

Figure 5-19 Calibration Dialog

Select the Menu Bar **Calibrate, From File** command; the **Display Calibration Graphs** dialog is invoked.

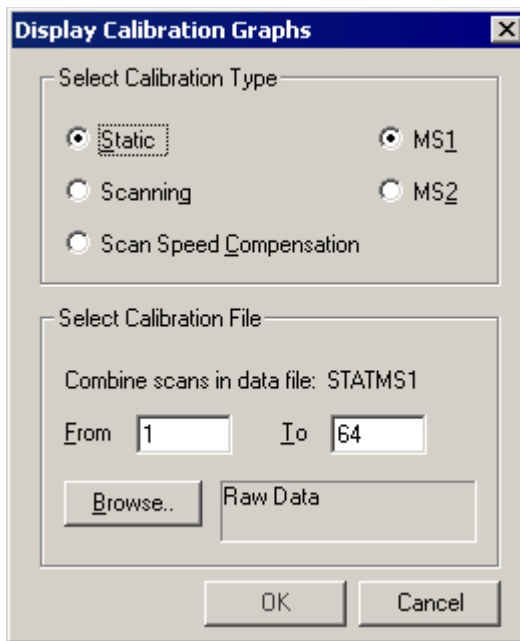

Figure 5-20 Display Calibration Graphs Dialog

Select the **Select Calibration Type** frame **Static** and **MS1** options.

Enter the reference data start and end scan numbers in the **Combine scans in data file:**, **From** and **To** text boxes.

Select the **OK** button.

The data in the .RAW mass spectrum file is processed and a calibration report is generated.

This report contains four displays:

- The acquired spectrum.
- The reference spectrum.
- A plot of mass difference against mass (the calibration curve).
- A plot of residual against mass.

An expanded region (following page lower) can be displayed by clicking and dragging with the left mouse button. In this way, the less intense peaks in the spectrum can be examined to check that the correct peaks have been matched. The peaks in the acquired

spectrum, which have been matched with a peak in the reference spectrum, are highlighted in a different color.

Compare the acquired and reference spectra to ensure that the correct peaks have been matched.

If insufficient peaks have been matched, or the wrong peaks have been matched, refer to the *Calibration Failure* section.

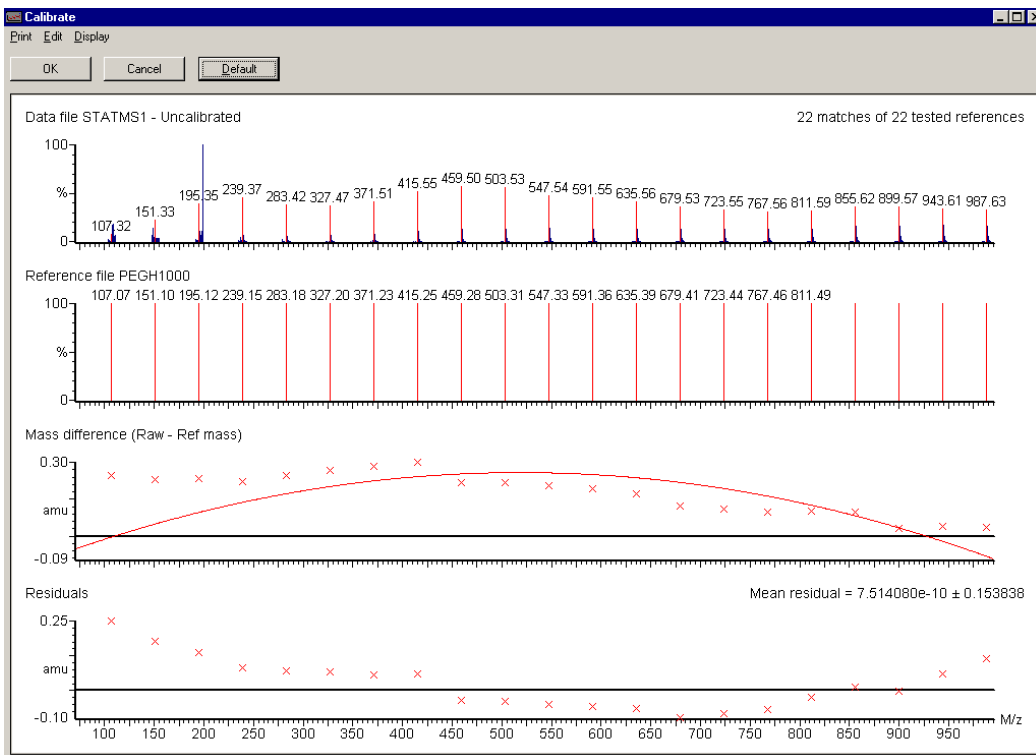

Figure 5-21 Calibration Report - Peak Matching

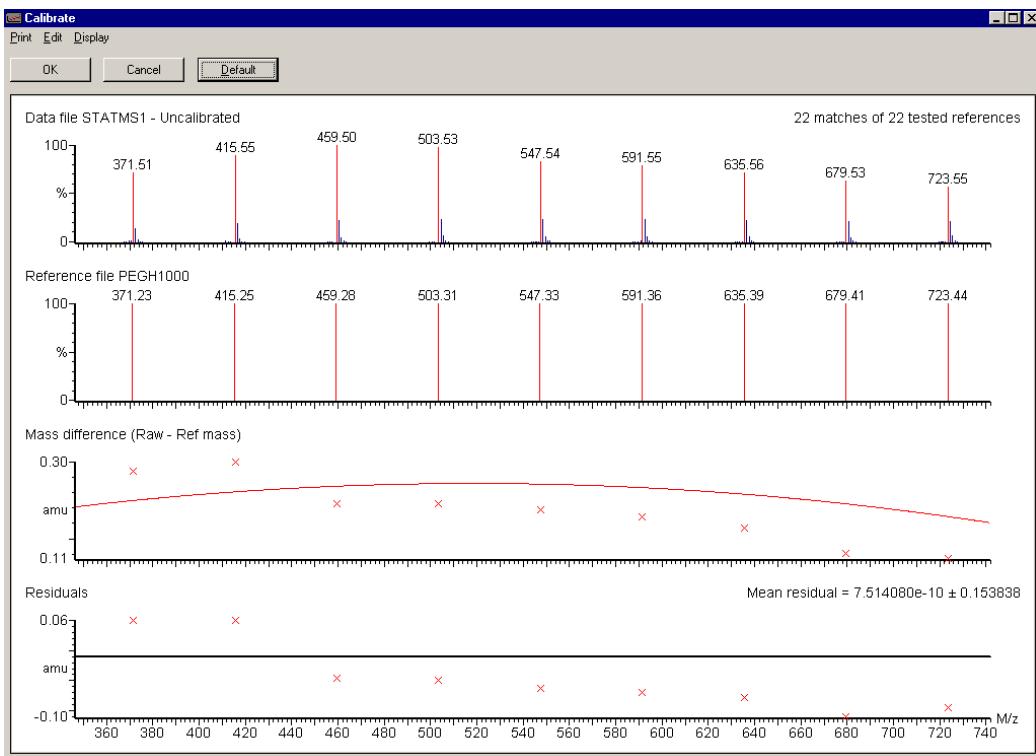

Figure 5-22 Calibration Report - Peak Matching

If the correct peaks have been matched, the report can be printed out:

Select the Calibration Report Menu Bar **Print, Print** command.

Printed: Thu Nov 27 17:02:31 1997

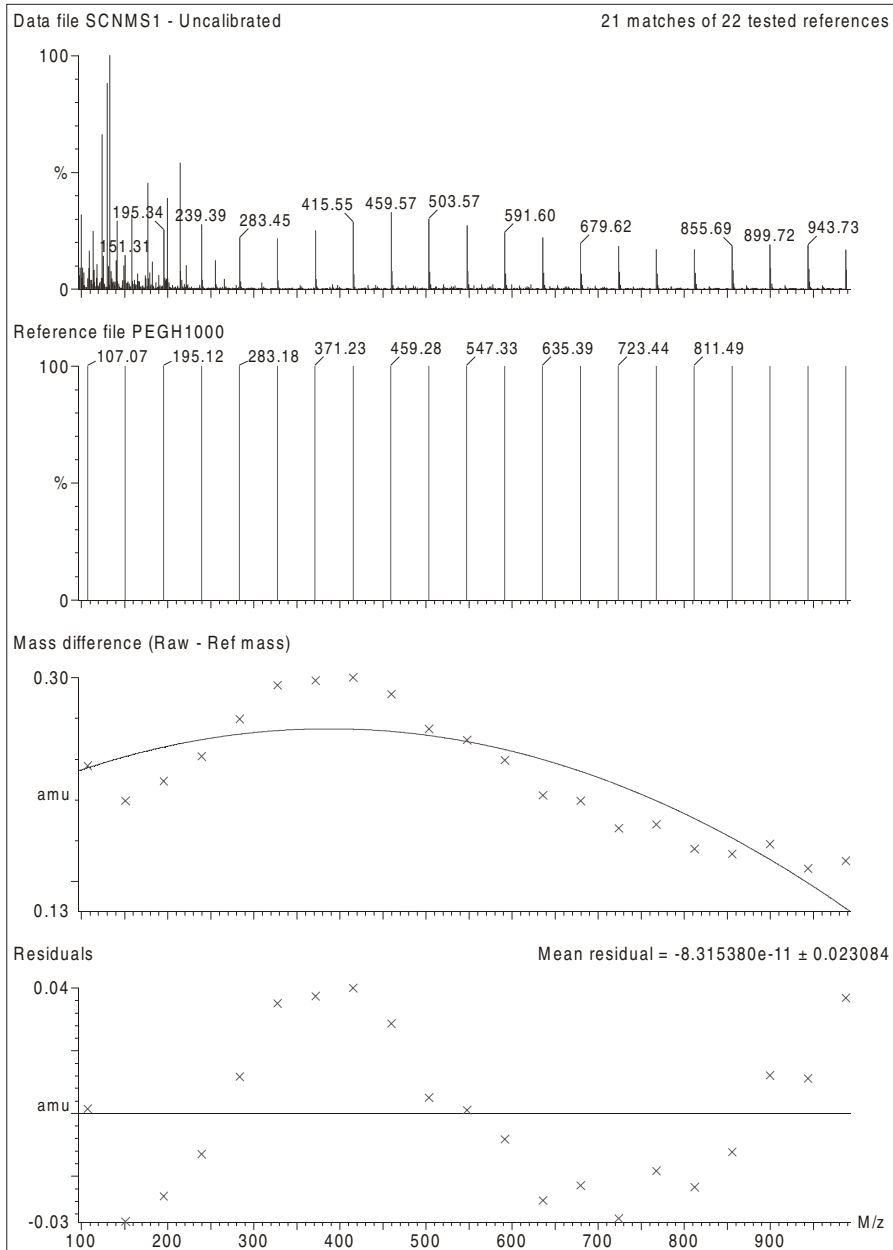

Figure 5-23 Calibration Report - Printout

5

To accept the calibration:

Select the Calibration Report **OK** button.

Scanning Calibration and Scan Speed Compensation

Acquiring Data

To complete the calibration of the instrument, two further data files must be acquired. Both files are acquired in scanning mode over the same mass range, one at the slowest speed required for scanning acquisitions and one at the fastest speed. Once these files have been acquired and used for calibration, data may be acquired anywhere within the mass range at any scan speed between the values used for the two sets of data. These data do not have to be acquired through the **Calibration** dialog, they can be acquired using the normal scan set-up and then accessed from the **Calibration** window as described below.

a) Scanning Calibration

The recommended scan speed for the scanning calibration is 100 amu/s.

In the **Calibration Acquisition Setup** dialog:

Set **Scan From** to 80 amu and **Scan To** to 1000 amu.

Set **Scan Time** to 9.2 sec and **Inter Scan Delay** to 0.1 s.

Set the **Data Type** to **Continuum**.

*Although **Continuum** is recommended, centroided data may be used.*

Set **Run Duration** to 2.0 minutes.

This allows time to start the acquisition, inject the reference solution, and acquire several scans. With a solvent flow rate of 200 $\mu\text{l}/\text{minute}$ and a 50 μl loop in line, an injection of reference solution lasts approximately 15 s allowing at least one full scan of useful data to be acquired.

Choose any file name for the data.

*The file name **SCNMS1**, the name used during an automatic calibration, is valid.*

Start the acquisition and inject the reference solution.

b) Scan Speed Calibration

The recommended scan speed for the scan speed compensation is 1000 amu/s. This is the maximum scan speed permissible when using thresholded continuum data.

*Although **Continuum** is recommended, centroided data may be used. It is possible to scan more quickly in centroided mode, but it is unlikely that a faster acquisition rate would be needed for general use.*

Set **Scan From** to 80 amu and **Scan To** to 1000 amu.

Set **Scan Time** to 0.92 sec and **Inter Scan Delay** to 0.1 s.

Select **Continuum** as the **Data Type**.

Set **Run Duration** to 2.0 minutes.

Choose any filename for the data.

The filename FASTMS1, the name used during an automatic calibration, is valid.

Start the acquisition and inject the reference solution.

Manual Calibration

Find the start and end scans of the reference data for each file in the same way as for the static calibration file.

Select the **Calibration** dialog Menu Bar **Calibrate, From File** command; the **Display Calibration Graphs** dialog is invoked

Select the **Select Calibration Type** frame **Scanning** and **MS1** options.

Enter the reference data start and end scan numbers in the **Combine scans in data file:, From** and **To** text boxes.

Select the **OK** button.

The data in the .RAW mass spectrum file is processed and a calibration report is generated in the same manner as for the static calibration.

Compare the acquired and reference spectra to ensure that the correct peaks have been matched.

If the correct peaks have been matched, the calibration report can be printed out:

Select the calibration report Menu Bar **Print, Print** command.

If insufficient peaks have been matched, or the wrong peaks have been matched, see the Calibration Failure section.

To accept the calibration:

Select calibration report **OK** button.

The same procedure is used for the scan speed compensation, except that the **Scan Speed Compensation** option is selected in the **Display Calibration Graphs** dialog, and the fast scanning file is used. Note that for the scan speed compensation, the default file is **FASTMS1**. If an alternative filename has been used then this must be selected using the data browser.

Once all three calibrations (static, scanning and scan speed compensation) have been completed, the instrument can be used for any mass range within the limits of the scanning calibrations and at any scan speed from 100 to 1000 amu/s.

Calibrating MS2

The calibration of MS2 is carried out in exactly the same manner as above, except that data are acquired in MS2 mode instead of MS1.

Once all six calibrations (static, scanning and scan speed compensation, each for both MS1 and MS2) have been completed, the instrument can be used for any mass range within the limits of the scanning calibrations, and at any scan speed from 100 to 1000 amu/s. Using the Instrument

5.4.6 Calibration Failure

When calibration is performed manually, there is no warning message to show that the calibration has not met the set criteria. This must be judged by viewing the on-screen calibration report and examining the matched peaks and statistics associated with the report. There are a number of reasons for a calibration to fail:

- No peaks. If the acquired calibration data file contains no peaks the calibration has failed. This may be due to:

Lack of reference compound.

Wrong scans or wrong data file being used for the calibration.

No flow of solvent into the source.

Multiplier set too low.

- Too many consecutive peaks missed. If the number of consecutive peaks which are not found exceeds the limit set in the Automatic Calibration Check parameters then the calibration has failed. Peaks may be missed for the following reasons:

The reference solution is running out causing less intense peaks to not be detected.

Multiplier is too low and less intense peaks are not detected.

The incorrect ionization mode is selected. Check that the data has been acquired with **Ion Mode** set to **APCI+**.

Intensity threshold, set in the **Calibration Parameters** dialog, is too high. Peaks are present in the acquired calibration file but are ignored because they are below the threshold level.

Either **Initial error** or **Peak window**, set in the **Calibration Parameters** dialog, is too small. The calibration peaks lie outside the limits set by these parameters.

Maximum Std Deviation (set in the **Automatic Calibration Check** dialog box) has been exceeded.

The wrong reference file has been selected. Check that the correct file (peg1000.ref in this case) is selected in the **Calibrate** dialog.

In the case of too many consecutive peaks missed:

Check the on-screen calibration report to see if the missed peaks are present in the acquired calibration file.

If the peaks are not present then the first three reasons above are likely causes.

If the peaks are present in the data, but are not recognized during calibration, then the latter four are likely reasons.

Having taken the necessary action, proceed as follows:

If **Intensity threshold**, **Initial error** and **Peak window** are adjusted to obtain a successful calibration, check the on-screen calibration report to ensure that the correct peaks have been matched.

With a very low threshold and wide ranges set for the initial error and peak window, it may be possible to select the wrong peaks and get a “successful”

calibration. This is particularly relevant for calibrations with PEG where there may be peaks due to PEG+H⁺, PEG+NH₄⁺ and PEG+Na. This situation is unusual, but it is always wise to examine the on-screen calibration report to check that the correct peaks have been matched.

Select **OK** from the calibration report window to accept the new calibration, or select **Cancel** to retain the previous calibration.

5.4.7 Incorrect Calibration

If the suggested calibration parameters are used and providing that good calibration data have been acquired, the instrument normally calibrates correctly. However, in some circumstances it is possible to meet the calibration criteria without matching the correct peaks.

This situation is unusual, but it is always wise to examine the on-screen calibration report to check that the correct peaks have been matched. These errors may occur when the following parameters are set:

- **Intensity threshold** set to 0
- **Initial error** too high (>2.0)
- **Peak window** too high (>1.5)
- **Maximum Std Deviation** too high (>0.2).

If the acquired spectrum looks like the reference spectrum and all of the expected peaks are highlighted, the calibration is OK.

An alternative cause of calibration failure is from contamination or background peaks. If a contamination or background peak lies within one of the peak matching windows, and is more intense than the reference peak in that window, then the wrong peak is selected.

Under some conditions, this may happen with PEG. There are two ways to counter this:

- If the reference peak is closer to the center of the peak window then the peak window can be narrowed until the contamination peak is excluded. Take care to ensure that no other reference peak is excluded.
- If the reference peak is not closer to the center of the peak window, or if by reducing the window, other reference peaks are excluded, then the calibration can be edited manually.

5.4.8 Manual Editing of Peak Matching

If an incorrect peak has been matched in the calibration process, this peak can be excluded manually from within the on-screen calibration report.

Using the mouse, right-click over the peak in the acquired spectrum.

The peak is excluded and is no longer highlighted.

If the true reference peak is present, this can be included in the calibration by the same procedure.

Using the mouse, right-click over the required peak.

The peak is matched with the closest peak in the reference spectrum.

Manually editing one peak does not affect the other matched peaks in the calibration.

5.4.9 Saving the Calibration

When the instrument is fully calibrated, the calibration can be saved under a filename so that it can be recalled for future use. For example, it is possible to save calibrations for use with different ionization modes, so that when an ionization source is switched the corresponding calibration is recalled.

The recalled calibration has the same constraints of mass range and scan speed. The ion energy and resolution settings used for the calibration acquisition are also recorded as these can have an effect on mass assignment.

5.4.10 Manual Verification

Once a full instrument calibration is in place, it is not always necessary to repeat the full calibration procedure when the instrument is next used. Instead, a calibration verification can be performed. (There is no benefit in verifying each calibration individually; re-calibration is just as quick.)

If a scanning acquisition is to be made and the calibration is to be checked:

Set up a scanning acquisition over the required mass range and at the required scan speed in the normal way.

Start the acquisition and inject the reference solution so that reference data is acquired.

Stop the acquisition.

Invoke the **Calibrate** dialog box and set all peak matching parameters to the same values that were used for the calibration.

Select the Menu Bar **Process, Verification from file** command; the **Display Verification Graphs** dialog is invoked.

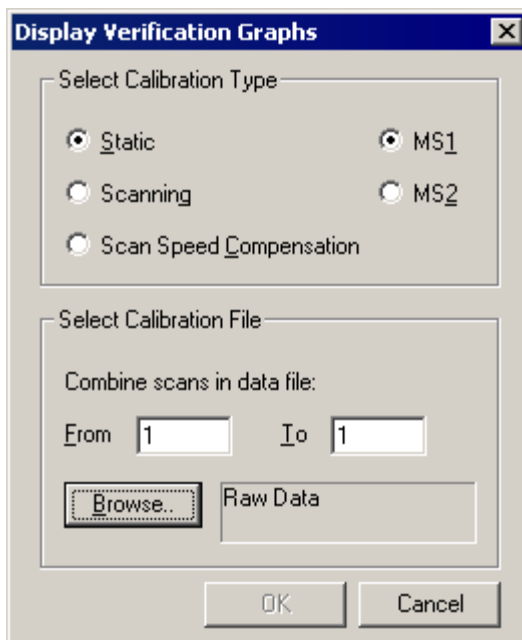

Figure 5-24 Display Verification Graphs Dialog

Select the **Select Calibration Type** frame **Scanning** option and either the **MS1** or **MS2** option, depending on the type of data acquired.

Select the **Select Calibration File** frame **Browse** button; the **Select file for verification** dialog is invoked.

Select the acquired file.

Select the **OK** button; the **Select file for verification** dialog is closed.

Enter the reference data start and end scan numbers in the **Combine scans in data file**; **From** and **To** text boxes.

Select the **OK** button; a calibration curve is produced and displayed on the screen in a similar way to that when the original calibration was performed.

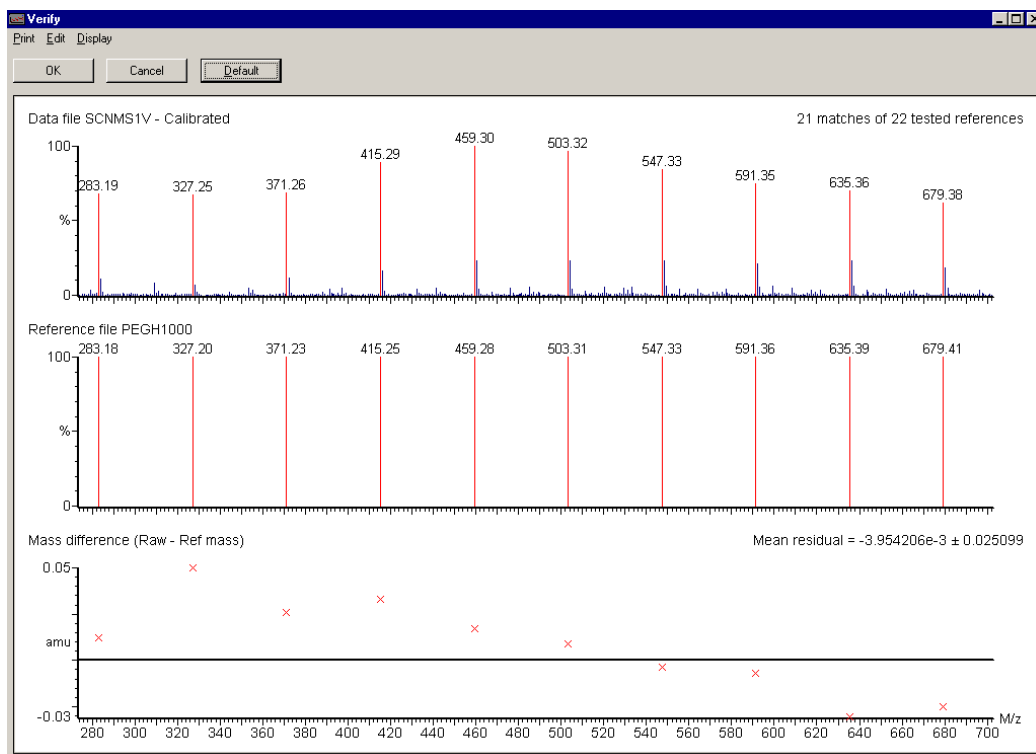

Figure 5-25 Calibration Report for Verification

Unlike the original calibration procedure, the instrument calibration is not changed when the **OK** button is selected from this report. As the verification procedure uses the same matching parameters as the calibration procedure, it is possible to validate the current calibration without re-calibrating the instrument.

The report can be printed out by selecting the verify report Menu Bar **Print, Print** command.

Chapter 6

ElectroSpray

6.1 Introduction

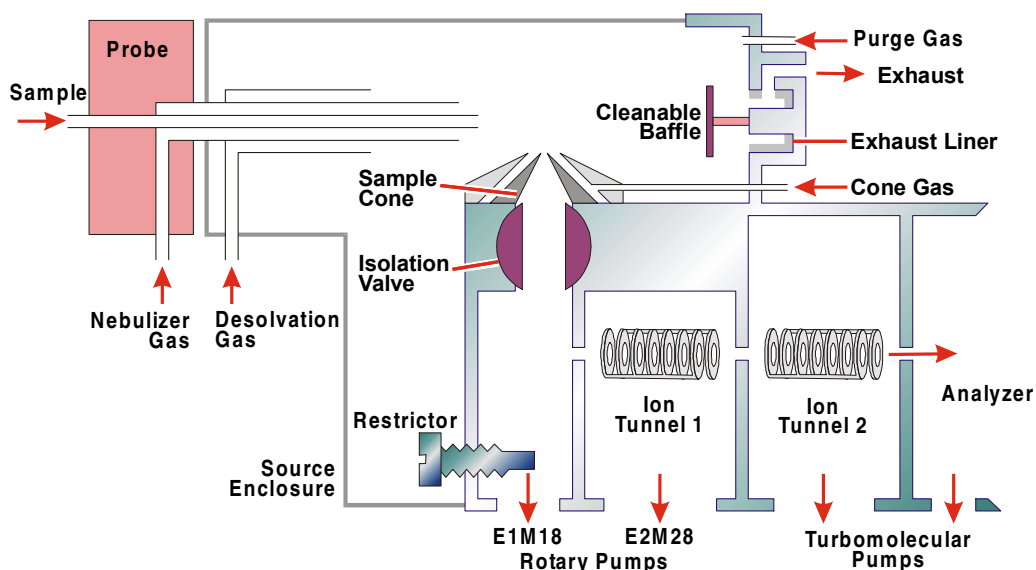

Figure 6-1 ElectroSpray Ionization

The ESI interface consists of the standard Z-spray source fitted with an ElectroSpray probe. See the *NanoFlow ElectroSpray* section for information concerning the optional NanoFlow interface.

Mobile phase from the LC column, or infusion pump, enters through the probe and is converted to a charged aerosol through nebulisation-assisted ElectroSpray. The solvent evaporates from the spray with the assistance of the heated desolvation gas. The resulting analyte and solvent ions are then drawn through the sample cone aperture into the ion block, prior to passing through the ion tunnels to the analyzer.

The ElectroSpray ionization technique allows rapid, accurate and sensitive analysis of a wide range of analytes from low molecular weight (less than 200 Da) polar compounds to biopolymers larger than 100 kDa.

Generally, compounds of less than 1000 Da produce singly charged protonated molecules ($[M+H]^+$) in positive ion mode. Likewise, these low molecular weight analytes yield ($[M-H]^-$) ions in negative ion mode, although this is dependent upon compound structure.

High mass biopolymers, for example peptides, proteins and oligonucleotides, produce a series of multiply charged ions. The acquired data can be transformed by the data system to give a molecular weight profile of the biopolymer.

The source can be tuned to fragment ions within the Ion Tunnel vacuum housing. This can provide valuable structural information for low molecular weight analytes.

The most common methods of delivering sample to the ElectroSpray source are:

- Syringe pump and injection valve.

A flow of mobile phase solvent passes through an injection valve to the ElectroSpray source. This is continuous until the pump syringes empty and need to be refilled. Sample is introduced through the valve injection loop (usually 10 or 20 μl capacity) switching the sample plug into the mobile phase flow. Tuning and acquisition are carried out as the sample plug enters the source. (At a flow rate of 10 $\mu\text{l}/\text{min}$ a 20 μl injection lasts 2 minutes.)

- Reciprocating pump and injection valve.

A flow of mobile phase solvent passes through an injection valve to the ElectroSpray source. Sample injection and analysis procedure is the same as for the syringe pump. The pump reservoirs are simply topped up for continuous operation. The most suitable reciprocating pumps for this purpose are those which are specified to deliver a flow between 1 $\mu\text{l}/\text{min}$ and 1 ml/min. A constant flow at such rates is more important than the actual flow rate. The injection valve on reciprocating pumps may be replaced by an autosampler for unattended, overnight operation.

- Infusion pump.

The pump syringe is filled with sample in solution. The infusion pump then delivers the contents of the syringe to the source at a constant flow rate. This arrangement allows optimization and analysis while the sample flows to the source at typically 5-30 $\mu\text{l}/\text{min}$. Further samples require the syringe to be removed, washed, refilled with the next sample, and replumbed.

A 50:50 mixture of acetonitrile and water is a suitable mobile phase for the syringe pump system and the reciprocating pump systems. This is appropriate for positive and negative ion operation.

Positive ion operation may be enhanced by 0.1 to 1.0% formic acid in the sample solution.

Negative ion operation may be enhanced by 0.1 to 1.0% ammonia in the sample solution. Acid should not be added in this mode.

These additives should not be used for Flow Injection Analysis (FIA) studies, to allow easy change over between positive and negative ion analysis.

Degassed solvents are recommended for the syringe and reciprocating pumps. Degassing can be achieved by sonification, or helium sparging. The solvents should be filtered, and stored under cover at all times.

It is wise to periodically check the flow rate from the solvent delivery system. This can be carried out by filling a syringe barrel, or a graduated glass capillary, with the liquid emerging from the probe tip and timing a known volume, say 10 μl . Once the rate has been measured and set, a note should be made of the backpressure readout on the pump, as fluctuation of this reading can indicate problems with the solvent flow.

6.1.1 Post-column Splitting

Although the ElectroSpray source can accommodate flow rates up to 1 ml/min, it is recommended that the flow is split post-column to approximately 200 $\mu\text{l}/\text{min}$. In addition, even at lower flow rates, a split may be required for saving valuable samples.

The post-column split consists of a zero dead-volume tee piece connected as shown.

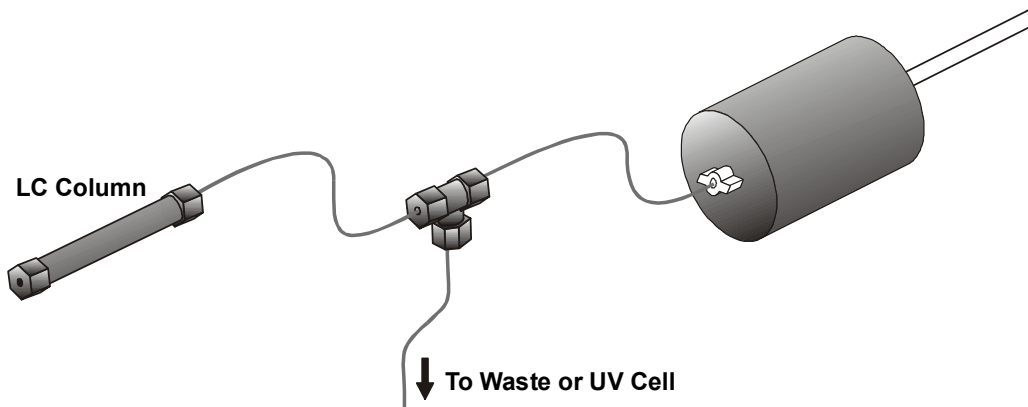

Figure 6-2 Post-column Splitting

The split ratio is adjusted by increasing or decreasing the backpressure created in the waste line, by changing either the length or the diameter of the waste tube. A UV cell may also be incorporated in the waste line, avoiding the requirement for in-line, low volume “Z cells”. As the backpressure is varied, the flow rate at the probe tip should be checked as described above.

These principles apply to splitting for both MegaFlow and normal flow ElectroSpray.

6.1.2 MegaFlow ElectroSpray

MegaFlow ElectroSpray enables flow rates from 200 $\mu\text{l}/\text{min}$ to 1 ml/min to be accommodated. This allows microbore (2.1 mm) or 4.6 mm diameter columns to be interfaced without splitting.

Changing Between Flow Modes

When changing between MegaFlow and standard ElectroSpray operation, it is essential that the correct tubing is used to connect the probe to the sample injector. For MegaFlow operation $1/16$ " o.d., 0.007" i.d. peek tubing, easily identified by its yellow stripe, is used. This replaces the standard fused silica tube, together with the PTFE sleeves.

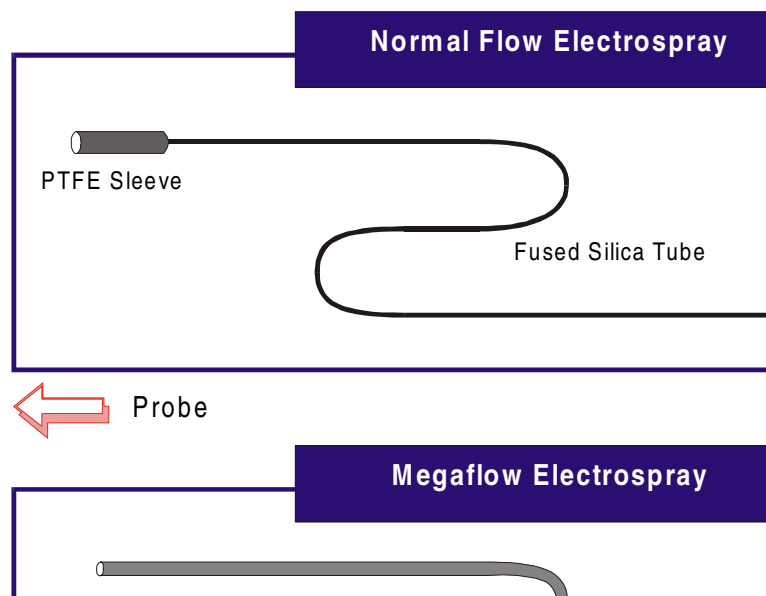

Figure 6-3 Changing Between Flow Modes

6.2 Operation

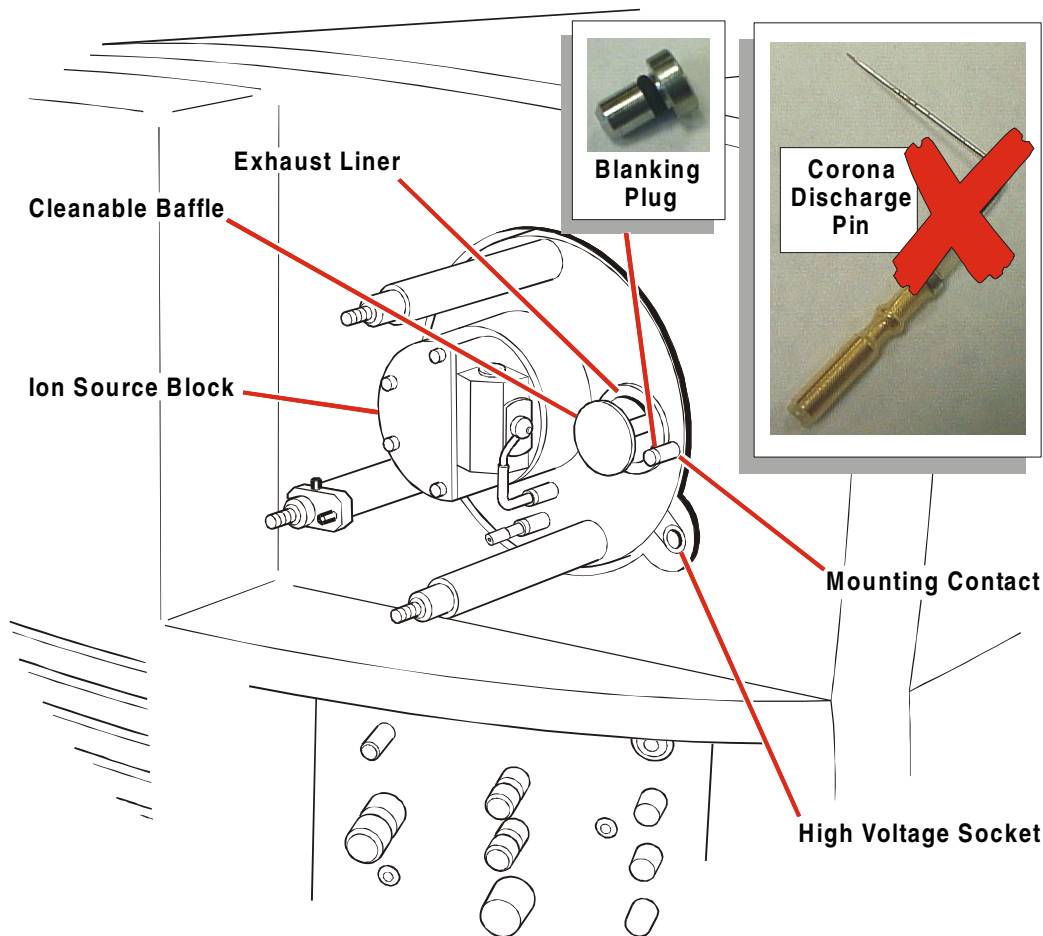

Figure 6-4 Source Setup for Electro spray

Ensure that the source is assembled as described in the *Maintenance and Fault Finding* section, and that the instrument is pumped down and prepared for ElectroSpray operation as described in the *Routine Procedures* section.

Ensure that a supply of nitrogen has been connected to the gas inlet at the rear of the instrument and that the head pressure is between 6 and 7 bar (90-100 psi).

Ensure that the exhaust liner and the cleanable baffle are fitted to the source.

This is important for optimum ElectroSpray intensity and stability when operating at low flow rates.

6.2.1 Checking the ESI Probe

Connect the ElectroSpray probe to a pulse free pump.

Solvent should be degassed to prevent beam instabilities caused by bubbles.

Connect the PTFE tubing of the ElectroSpray probe to the front panel **Nebulising Gas** connection. Secure with the nut provided.

With the probe removed from the source, turn on the liquid flow at 10 $\mu\text{l}/\text{min}$ and check that liquid flow is observed at the tip of the capillary.

To avoid unwanted capillary action effects, do not allow liquid to flow to the probe for long periods without the nitrogen switched on.

Turn on the nitrogen by selecting the Tune Page Menu Bar **Gas**, **Gas** command and fully open the front panel **Nebuliser** gas flow control valve.

Check that there is gas flow at the probe tip and ensure that there is no significant leakage of nitrogen elsewhere.

Adjust the probe tip to ensure complete nebulisation of the liquid.

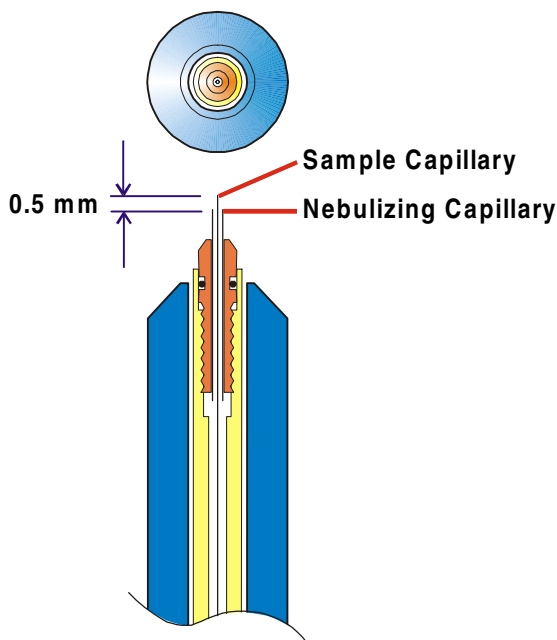

Figure 6-5 Probe Tip Capillary Fine Adjustment

There should be approximately 0.5 mm of sample capillary protruding from the nebulizing capillary.

The tip of the ElectroSpray probe can influence the intensity and stability of the ion beam. A damaged or incorrectly adjusted probe tip leads to poor ElectroSpray performance.

Using a magnifying glass, ensure that both inner and outer stainless steel capillaries are straight, and circular in cross-section.

Ensure that the inner stainless steel capillary is coaxial to the outer capillary.

If the two capillaries are not coaxial, it is possible to bend the outer capillary slightly using thumbnail pressure.

Insert the probe into the source and tighten the two thumbscrews.

Plug the probe high voltage cable into the front panel **Capillary/Corona** connection.

6.2.2 Obtaining an Ion Beam

If necessary, change the ionization mode using the Tune Page Menu Bar **Ion Mode** menu.

The top line of the tune page indicates the current ionization mode.

Using the needle valve, on the front panel, set the desolvation gas flow rate to 300 l/h.

*To monitor the flow rate, select the Tune Page **Source** tab and observe the **Gas Flows** read-back window.*

Turn on the liquid flow at 10 $\mu\text{l}/\text{min}$ and set **Desolvation Temp** to 100 °C.

Tuning and Optimization

The following parameters, after initial tuning, should be optimized using a sample representative of the analyte to be studied. It is usually found, with the exception of the sample cone voltage, that settings vary little from one analyte to another.

Probe Position

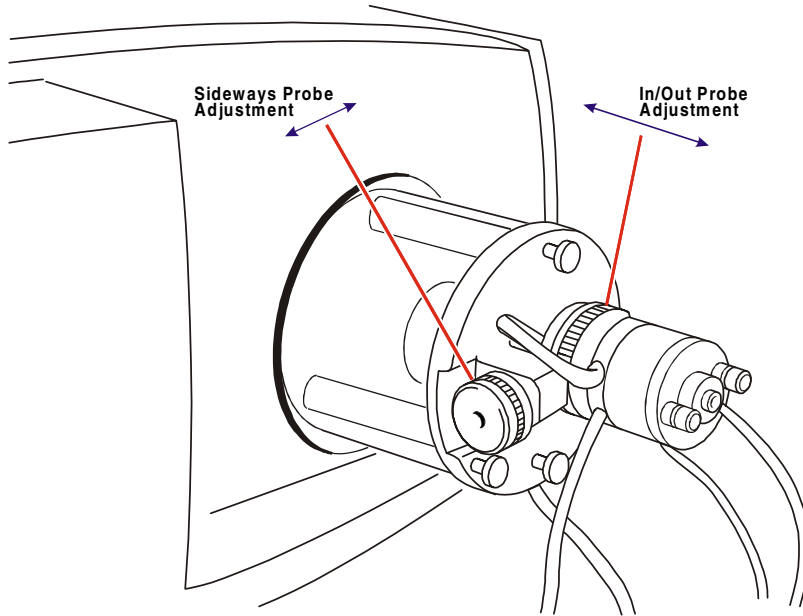

Figure 6-6 Start Acquisition Dialog

The position of the probe is adjusted using the probe adjustment collar (in/out) and the adjustment knob (sideways) located to the left of the probe. The two screws can be adjusted singly or simultaneously to optimize the beam. The position for optimum sensitivity and stability for low flow rate work ($10 \mu\text{l}/\text{min}$) is shown.

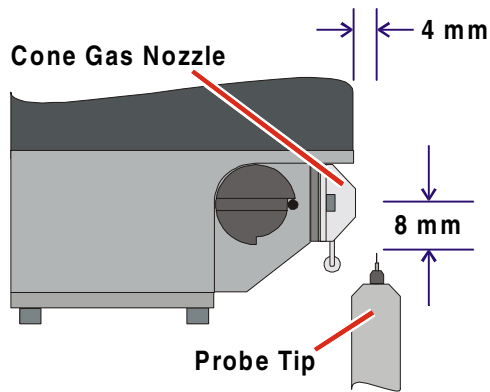

Figure 6-7 Probe Adjustment

Small improvements may be gained by varying the position using the sample and solvent system under investigation. The following information should be considered when setting the probe position:

- 10 mm of movement is provided in each direction, with 1.25 mm of travel per revolution of the probe positioning controls.
- At higher liquid flow rates, the probe tip should be positioned further away from the sample cone to achieve optimum stability and sensitivity. The position is less critical than at lower flow rates.

Nebulizer Gas

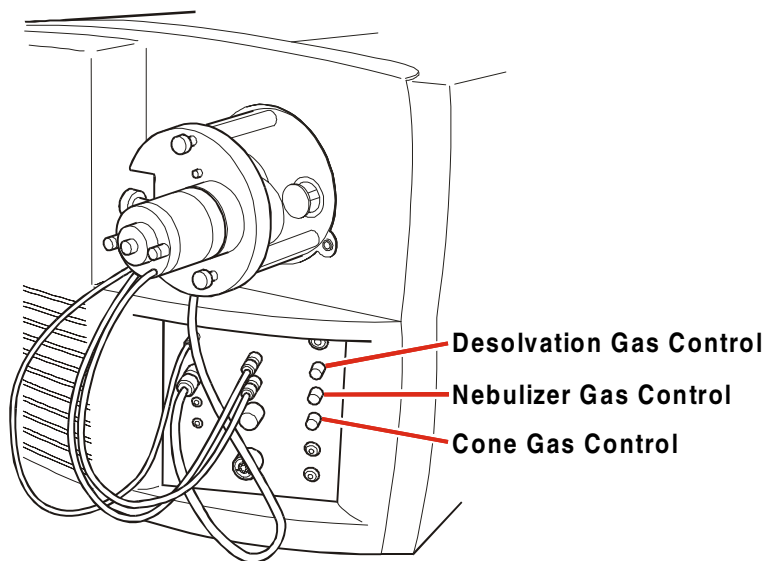

Figure 6-8 Gas Flow Controls

Optimum nebulization for ElectroSpray performance is achieved by fully opening the **Nebuliser** flow control valve, which is situated on the instrument's front panel.

Desolvation Gas



Caution: Do not operate the desolvation heater for long periods without a gas flow, as this may damage the source.

The desolvation gas is heated and delivered as a coaxial sheath to the nebulised liquid spray by the desolvation nozzle.

The position of the desolvation nozzle heater is fixed relative to the probe tip and requires no adjustment.

The **Desolvation Gas** flow rate is adjusted by the control value situated on the instrument's front panel. The optimum **Desolvation Temp** and flow rate is dependent on mobile phase composition and flow rate. A guide to suitable settings is given below.

To monitor the flow rate, select the Tune Page **Source** tab and observe the **Gas Flows** read-back window. The **Desolvation** gas flow rate includes purge gas (if enabled).

Solvent Flow Rate ($\mu\text{l}/\text{min}$)	Desolvation Temp ($^{\circ}\text{C}$)	Desolvation Gas Flow Rate (l/h)
<10	100 to 120	200 to 250
10 to 20	120 to 250	200 to 400
20 to 50	250 to 350	200 to 400
>50	350 to 400	500 to 750

Higher desolvation temperatures give increased sensitivity. However increasing the temperature above the range suggested reduces beam stability. Increasing the gas flow rate higher than the quoted values leads to unnecessarily high nitrogen consumption.

Cone Gas

The cone gas reduces the intensity of solvent cluster and adduct ions. The cone gas flow rate should be increased until solvent cluster ions and/or adduct ions are reduced as much as possible without diminishing the intensity of the ion of interest, normally $(\text{M}+\text{H})^{+}$.

Typical cone gas flow rates are in the range 100 to 300 l/h.

*To monitor the flow rate, select the Tune Page **Source** tab and observe the **Gas Flows** read-back window.*

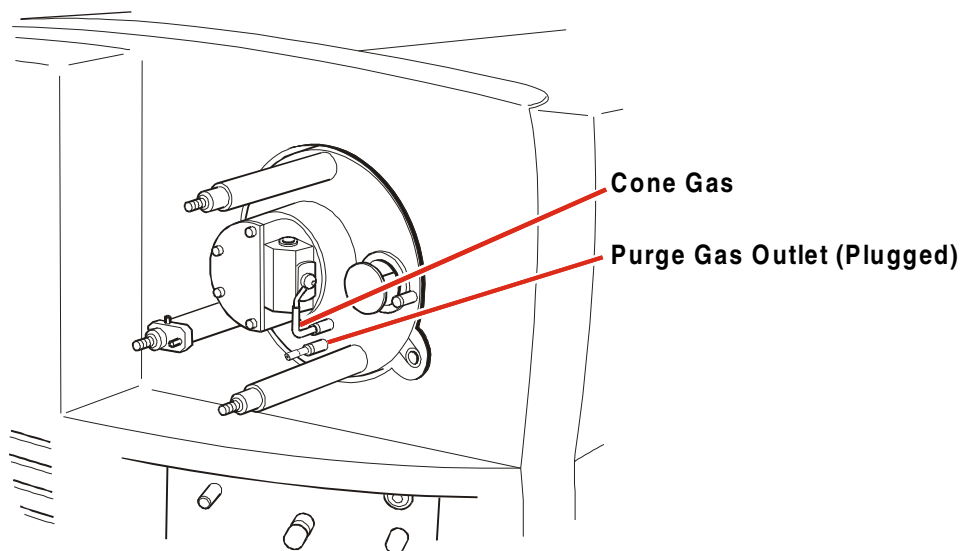

Figure 6-9 Cone Gas

Purge Gas

The purge gas is not necessary for most ElectroSpray applications. It allows purging of the source volume to remove excessive solvent vapor.

Purge gas is enabled simply by removing the blanking plug from the outlet situated within the source enclosure.

Purge gas flow rate is a constant fraction (30%) of the total desolvation gas flow.

Restrictor



Warning: The restrictor is held at sample cone potential; it must not be adjusted with the instrument in the **Operate** mode.

The restrictor is positioned on the opposite side of the source block to the sample cone. Screwing the restrictor into the source block restricts the pumping port and increases the source block pressure.

The restrictor is factory-adjusted for optimum sensitivity on low molecular weight singly charged species. For higher molecular weight compounds (proteins and peptides) there is usually an increase in sensitivity if the restrictor is wound further into the source block. If the majority of samples to be analyzed are higher molecular weight compounds, it is

recommended that the restrictor is re-optimized for these compounds. Continual adjustment and re-adjustment of the restrictor position is not recommended.

The source glass must be removed to gain access to the restrictor. It is recommended that the original position of the restrictor is noted and subsequent adjustment made in half turn increments to obtain the optimum position.

Tune Page Parameters

The following parameters can all be found on the MassLynx Tune Page.

Source Temperature



Caution: The maximum operating temperature for the source heater is 150 °C. Do not set **Source Temp** (°C) higher than 150 °C.

A **Source Temp** (°C) of 100 °C is typical for 50:50 CH₃CN:H₂O at solvent flow rates up to 50 µl/min. Higher source temperatures, up to 150 °C, are necessary for solvents at higher flow rates and higher water content.

Capillary Voltage

Capillary (kV) usually optimizes at 3.0 kV, although some samples may tune at values above or below this, within the range 2.5 to 4.0 kV for positive ElectroSpray. For negative ion operation, a lower voltage is necessary, typically between 2.0 and 3.5 kV.

At high flow rates, this parameter may optimize at a value as low as 1.0 kV.

Sample Cone Voltage

A **Cone** setting between 50 V and 100 V produces ions for most samples, although solvent ions prefer the lower end and proteins the higher end of this range. Whenever sample quantity and time permit, **Cone** should be optimized for maximum sensitivity.

RF Lens 1 Voltage

RF Lens 1 settings between 0 and 50 V can be beneficial in removing solvent adducts from certain samples. Values of 50 V and above can provide efficient fragmentation of sample ions. As for **Cone**, this parameter should be optimized for maximum sensitivity.

Aperture Voltage

This parameter generally optimizes at 0 V.

RF Lens 2 Voltage

RF Lens 2 should normally be operated between 0.2 and 0.5 V. A setting of 0.5 V can be particularly beneficial when using short interscan times and short dwell times (<100 ms).

Low Mass Resolution and High Mass Resolution

Peak width is affected by the values of low mass resolution (**LM Res**) and high mass resolution (**HM Res**). Both values should be set low (typically 5.0) at the outset of tuning and only increased for appropriate resolution after all other tuning parameters have been optimized. A value of 15 (arbitrary units) usually gives unit mass resolution on a singly charged peak up to m/z 1600.

Ion Energy

The ion energy parameter usually optimizes in the range 0 V to 3 V. It is recommended that the value is kept as low (or negative) as possible without reducing the height intensity of the peak. This helps obtain optimum resolution.

If, in positive ion mode, an ion energy value below -1 V can be used without reducing the peak intensity, source cleaning is recommended.

Collision Gradient

The Collision Gradient can be operated in two modes:

- **Manual.** The gradient voltage applied to the gas cell is controlled using the slider on the Tune Page.

Note:

Setting too low a gradient for MSMS operation in the Manual mode can result in a high degree of cross-talk between channels.

- **Automatic.** The gradient voltage applied to the gas cell is set to predetermined optimum values, depending on the mode of operation.

Note: *When the Automatic mode is selected, the Tune Page collision gradient control is disabled.*

The Tune Page Menu Bar **Options**, **Manual Collision Gradient** command toggles between the Manual and Automatic modes; a tick mark appears beside the command when the Manual mode is operational.

6.2.3 Megaflow Hints



Warning: It is normal for the source enclosure, the glass tube and parts of the probe mounting flange, to get hot during prolonged MegaFlow operation. Care should be taken when handling source components during and immediately after operation.

The source enclosure runs cooler if purge gas is used.



Warning: For health and safety reasons, always ensure the exhaust line is vented outside the building, or to a fume hood.



Warning: Ensure that a plastic bottle is connected in the exhaust line to collect any condensed solvents.

With this high flow rate technique, the set-up procedure involves making the following adjustments:

- Increase **Drying Gas** flow to approximately 750 l/h.
- Increase **Desolvation Temp** to 400 °C.
- Increase **Source Temp** to 150 °C.
- Move the probe further away from the sample cone.

When changing from ElectroSpray to MegaFlow operation it is not necessary to adjust any source voltages.

Cluster ions are rarely observed with Z-spray. However, solvent droplets may form within the source enclosure if the source and desolvation temperatures are too low.

Refer to the previous section on operating parameters for typical desolvation gas flow rates.

If the sample is contained within a ‘dirty matrix’, the probe may be moved away from the sample cone to extend time between source cleaning operations. This may incur a small loss in sensitivity.

6.2.4 Removing the Probe

To remove the probe from the source, proceed as follows:

Select the Tune Page  button.

Switch off the liquid flow and disconnect from the probe.

Select the Tune Page Menu Bar **Gas, Gas** command to turn off the nitrogen.

Disconnect the probe cable from the instrument.

Disconnect the nebulising gas supply from the instrument.

Unscrew the probe thumbscrews (2-off).

Remove the probe.

6.3 Sample Analysis and Calibration

6.3.5 General Information

Care should be taken to ensure that samples are fully dissolved in a suitable solvent. Any particulates must be filtered to avoid blockage of the transfer line or the probe's capillary. A centrifuge can often be used to separate solid particles from the sample liquid.

There is usually no benefit in using concentrations greater than 20 pmol/ μl for biopolymers or 10 ng/ μl for low molecular weight compounds.

Higher concentrations do not usually improve analytical performance. Conversely, for biopolymers, lower concentrations often yield better ElectroSpray results. Higher levels require more frequent source cleaning and risk blocking the transfer capillary.

Optimization for low molecular weight compounds may usually be achieved using a concentration of 1 ng/ μl .

Samples with phosphate buffers and high levels of salts should be avoided. Alternatively, at the expense of a small drop in sensitivity, the probe can be pulled away from the sample cone to minimize the deposit of involatile material on the cone.

To gain experience in sample analysis, it is advisable to start with the qualitative analysis of known standards. A good example of a high molecular weight sample is horse heart

myoglobin (molecular weight 16951.48); this produces a series of multiply charged ions that can be used to calibrate the m/z scale from 800-1600 in either positive ion or negative ion mode.

Polyethylene glycol mixtures, for example 300/600/1000, are low molecular weight samples suitable for calibrating the m/z scale from approximately 100 to 1200 in positive ion mode. A mixture of sugars covers the same range in negative ion mode.

Alternatively, a mixture of sodium iodide and caesium iodide (or a mixture of sodium iodide and rubidium iodide) can be used for calibration.

Detailed information on data acquisition and processing can be found in the *MassLynx NT User's Guide*. Detailed information on mass calibration can be found in the *Mass Calibration* section.

Typical ES Positive Ion Samples

- Peptides and proteins.
- Small polar compounds.
- Drugs and their metabolites.
- Environmental contaminants (e.g. pesticides / pollutants).
- Dye compounds.
- Some organometallics.
- Small saccharides.

Typical ES Negative Ion Samples

- Some proteins.
- Some drug metabolites (e.g. glucuronide conjugates).
- Oligonucleotides.
- Some saccharides and polysaccharides.

6.4 Chromatographic Interfacing

ElectroSpray ionization can be routinely interfaced to reversed phase and normal phase chromatographic separations. Depending on the LC pumping system, chromatography column and set-up, there are some basic options:

- Microbore and capillary chromatography separations employing 1 mm diameter (and smaller) columns can be interfaced directly to the ElectroSpray probe. Typical flow rates for such columns may be in the region of 3-50 $\mu\text{l}/\text{min}$. It is suggested that a syringe pump is used to deliver these constant low flow rates through a capillary column. Alternatively, accurate pre-column splitting of higher flow rates from reciprocating pumps can be investigated.

In all cases, efficient solvent mixing is necessary for gradient elution separations. This is of paramount importance with regard to low flow rates encountered with capillary columns. HPLC pump manufacturers' recommendations should be heeded.

- 2.1 mm diameter reversed phase columns are gaining popularity for many separations previously addressed by 4.6 mm columns. Typically, flow rates of 200 $\mu\text{l}/\text{min}$ are used, allowing direct coupling to the ElectroSpray source. The increased sample flow rate requires increased source temperature and drying gas flow rate.

A UV detector may be placed in-line to the Quattro Ultima Pt probe. However, ensure that the volume of the detector does not significantly reduce the chromatographic resolution. Whenever a UV detector is used, the analog output may be input to MassLynx NT for chromatographic processing.

- The interfacing of 4.6 mm columns to the ElectroSpray source can be achieved either by flow splitting or by direct coupling. In both cases, an elevated source temperature and drying gas flow rate are required. In general, the best results are obtained by splitting after the column using a zero dead volume tee piece so that 200-300 $\mu\text{l}/\text{min}$ is transferred to the source.

Conventional reverse phase and normal phase solvent systems are appropriate for LC-ElectroSpray.

Involatile buffers may be used but prolonged periods of operation are not recommended. When using involatile buffers the probe should be moved as far away from the sample cone as possible. This may reduce sensitivity slightly, but also reduces the rate at which involatile material is deposited on the sample cone.

Trifluoroacetic acid (TFA) and triethylamine (TEA) may be used up to a level of 0.05%. If solvents of high aqueous content are to be used then tuning conditions should be appropriate for the solvent composition entering the source.

Higher source temperatures (150 °C) are also recommended for high aqueous content solvents. Tetrahydrofuran (THF) should *not* be used with peek tubing.

6.4.1 LC-MS Sensitivity Enhancement

The sensitivity of a LC-MS analysis can be increased or optimized in a number of ways, by alterations to both the LC operation and the MS operation.

In the LC area some examples include the use of high resolution columns and columns with fully end-capped packings. For target compound analysis, techniques such as trace enrichment, coupled column chromatography, or phase system switching can have enormous benefits.

Similarly, the mass spectrometer sensitivity can often be significantly increased, for instance by narrow mass scanning or by single ion recording (SIR) techniques.

Careful choice of the solvent, and solvent additives or modifiers may also prove important.

Chapter 7

Atmospheric Pressure Chemical Ionization

7.1 Introduction

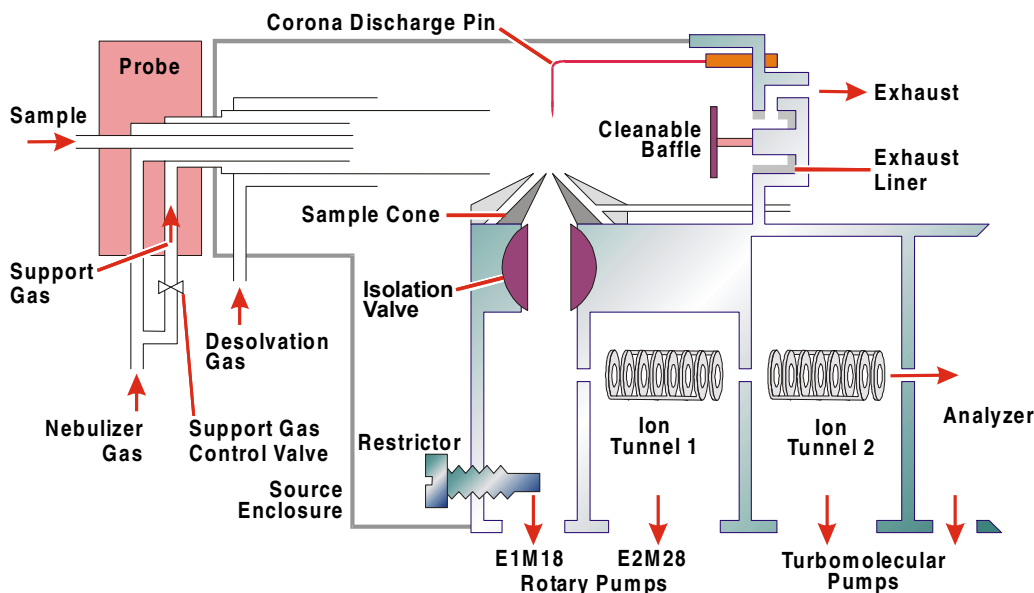

Figure 7-1 APCI

Atmospheric Pressure Chemical Ionization (APCI) is an easy to use LC-MS interface that produces singly-charged protonated or deprotonated molecules for a broad range of involatile analytes.

The ability to operate with 100% organic or 100% aqueous mobile phases at flow rates up to 2 ml/min makes APCI an ideal technique for standard analytical column (4.6 mm i.d.) normal phase and reverse phase LC-MS.

The APcI interface consists of the standard Z-spray source fitted with a corona discharge pin and a heated nebuliser Ion Sabre APcI probe. Mobile phase from the LC column enters the probe where it is pneumatically converted into an aerosol and is rapidly heated and converted to a vapor/gas at the probe tip. Hot gas from the probe passes between the sample cone and the corona discharge pin; this is typically operated with a discharge current of 5 μA .

Mobile phase molecules rapidly react with ions generated by the corona discharge to produce stable reagent ions. Analyte molecules introduced into the mobile phase react with the reagent ions at atmospheric pressure and typically become protonated (in positive ion mode) or deprotonated (in the negative ion mode). The sample and reagent ions pass through the sample cone into the ion block prior to transit through the ion tunnels to the analyzer.

Changeover between ElectroSpray and APcI operation is simply accomplished by changing the probe and installing the corona discharge pin within the source enclosure; see the section *Routine Procedures, Preparation for Ion Sabre APcI Operation*.

For APcI operation, the desolvation gas is not heated in the desolvation nozzle. However, it is important that desolvation gas is used throughout.

The support gas flow is controlled by the probe-mounted Support Gas Control Valve.

Acetonitrile adducting may be minimized by optimization of the **Cone** gas and **RF Lens 1** voltage, as described in the *ElectroSpray* section.

7.2 Preparation

Ensure that the source is assembled as described in the *Maintenance and Fault Finding* section, and that the instrument is pumped down and prepared for APcI operation as described in the *Routine Procedures* section.

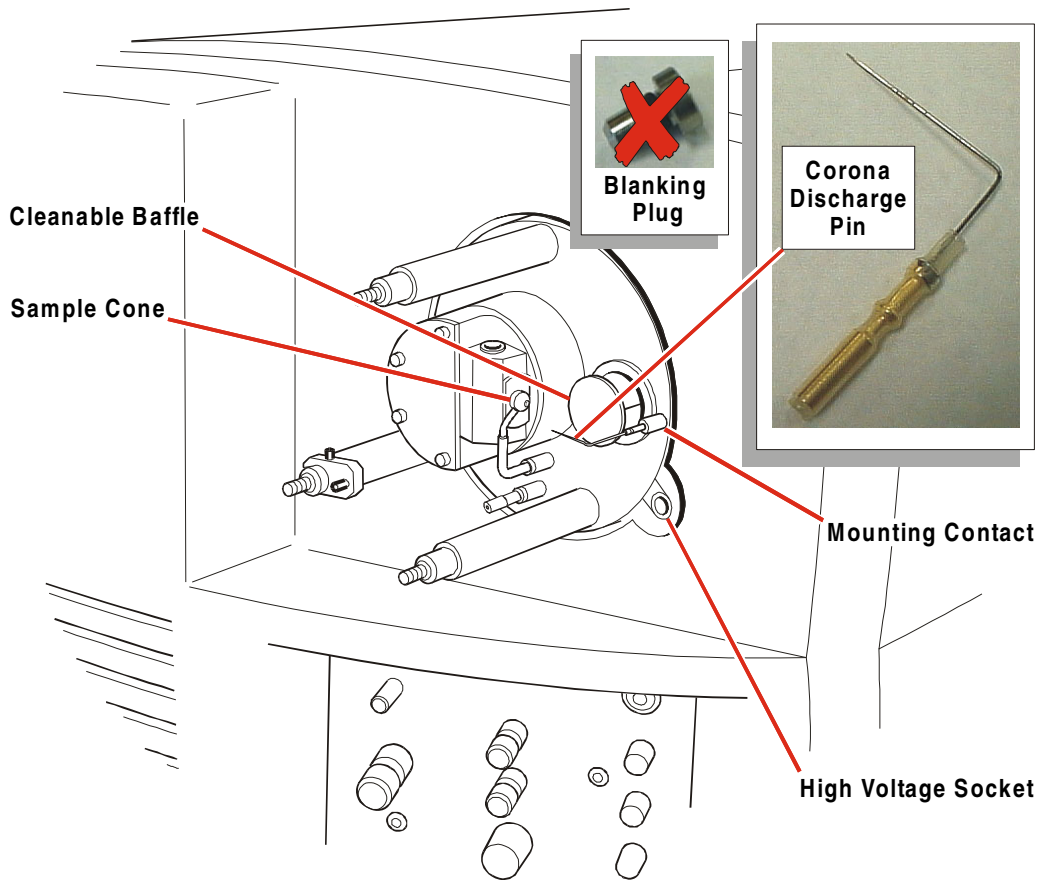

Figure 7-2 Source Setup for APcI

APcI may be operated with or without the cleanable baffle fitted.

Ensure that a supply of nitrogen has been connected to the gas inlet at the rear of the instrument and that the head pressure is between 6 and 7 bar (90-100 psi).

7.2.1 Checking the Probe

Ensure that the probe heater is switched off.

Unplug the probe from the instrument's front panel and remove the probe from the source.

Connect the PTFE tube to the **Nebuliser** outlet on the front panel.

Remove the probe tip assembly by carefully loosening the two grub screws.

Disconnect the heater from the probe body by pulling parallel to the axis of the probe.

Ensure that 0.5 to 1.0 mm of fused silica is protruding from the stainless steel nebuliser tube.

Connect the LC pump to the probe with a flow of 50:50 acetonitrile:water at 1 ml/min.

Check that the liquid jet flows freely from the end of the capillary and that the LC pump backpressure reads 250 to 400 psi.

Check that the nitrogen supply pressure is 6 to 7 bar (90 to 100 psi).

Check that the support gas is set to 1.0.

Select the Tune Page Menu Bar **Gas, Gas** command to turn on the nitrogen.

Check that the liquid jet converts to a fine uniform aerosol.

Switch off the liquid flow.

Select the Tune Page Menu Bar **Gas, Gas** command to turn off the nitrogen.

Reconnect the probe tip assembly.

Insert the APcI probe into the source and secure it by tightening the two thumbscrews.

Disconnect the plug labeled *ESI* (from the probe adjustment flange) from the front panel.

Connect the probe cable to the front panel **APcI/ESI** socket.

7.3 Obtaining an Ion Beam



Warning: It is normal for the source enclosure, the glass tube and parts of the probe adjustment flange to reach temperatures of up to 80 °C during prolonged APcI operation. The protective cover provided with the APcI probe must be fitted over the glass enclosure to prevent contact with the hot glass surfaces. Care should be exercised when handling source components immediately after operation.



Warning: Switch off the liquid flow and allow the probe to cool before removing it from the source.



Caution: Failure to employ a desolvation gas and support gas flow during APcI operation may lead to heat damage to the source and APcI heater.

Ensure that the corona discharge pin is fitted and connected as described in the *Routine Procedures, Preparation for APcI Operation* section.

Ensure that the APcI probe is fitted as described above, that the desolvation gas tube is connected to the front panel, and that the purge gas outlet is plugged.

If necessary, change the ionization mode using the Tune Page Menu Bar **Ion Mode** menu.

The top line of the tune page indicates the current ionization mode.

Set **Source Temp** (°C) to 130 °C.

Set **APcI Probe Temp** (°C) to 20 °C with no liquid flow and the nitrogen off.

Set **Corona** (uA) to 5 μA.

Set **Cone** to 50 V.

When **Source Temp** (°C) reaches 130 °C:

Select the Menu Bar **Gas**, **Gas** command to switch on the nitrogen gas.

Using the valves on the front of the instrument, adjust **Desolvation Gas** to 150 l/h and set **Nebuliser Gas** to its maximum setting.

Set the support gas to 1.0.

*To monitor the flow rate, select the Tune Page **Source** tab and observe the **Gas Flows** read-back window.*

Select one of the peak display boxes and set **Mass** to 50 and **Span** to 90.

Select the  button.

Increase **Gain** in the range 1 to 20 until peaks become clearly visible.

Set **APCI Probe Temp** (°C) to 500 °C.

When **APCI Probe Temp** (°C) reaches 500 °C:

Start the LC pump at a flow of 1 ml/min.

Adjust the probe's in/out position so that it is fully retracted.

Adjust the probe's sideways position so that the spray is directed approximately at the midpoint between the corona pin and the sample cone.

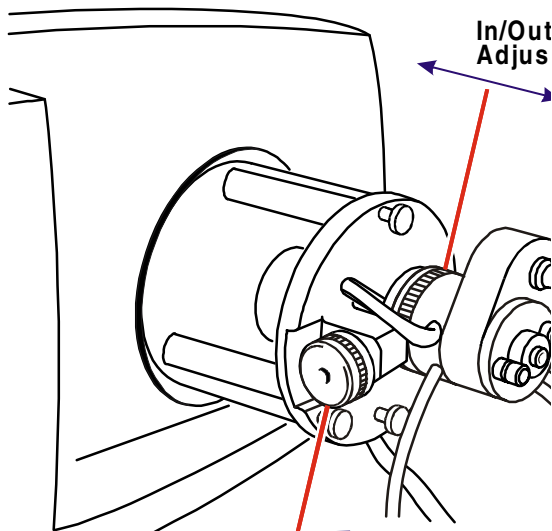

Figure 7-3 Probe Adjustments

Check that a stable beam of solvent ions is now apparent.

Refer to the Hints for Sample Analysis section for further information on source tuning.

7.4 Calibration

Having obtained a stable APcI beam, refer to the *Mass Calibration* section.

7.5 Hints for Sample Analysis

7

7.5.2 Tuning for General Qualitative Analysis

Refer to the Obtaining an Ion Beam Beam section and tune on solvent ions.

Adjust the in/out position of the probe so that it is fully retracted from the source.

Using the sideways adjuster ensure that the spray is directed approximately at the mid-point between the corona pin and the sample cone.

This position occurs five full turns away from the stop closest to the corona pin.

For general qualitative analysis of mixtures, the following parameters are typical:

Corona: 5 μ A.*

Cone: 80 V.

RF Lens 1: 40 V.

Aperture: 0 V.

RF Lens 2: 0.5 V.

Source Temp: 130 °C.

APcI Probe Temp: 500 °C.*

Desolvation Gas: 150 l/h.*

Cone Gas: 100 l/h.

Support Gas: 1.0.

** See the following section for specific tuning details.*

7.5.3 Specific Tuning for Maximum Sensitivity

- For quantitative MRM analysis, optimum APcI conditions should be obtained for each analyte using standard solutions.
- Tuning may be performed using a tee to introduce a standard solution (typically 100 pg/μl) at 10 μl/min into the mobile phase stream.
- Alternatively, repeat direct loop injections of a standard solution (typically 10 pg/μl) into the mobile phase stream may be used, while acquiring in the MRM acquisition mode, to optimize the APcI. During an acquisition the source parameters may be adjusted and the effects observed.

Corona Current

Corona current can have a significant effect on sensitivity. The corona current required can depend upon the polarity of the compound and the polarity of the analytical mobile phase. As recommended above optimization should be done in the presence of the analytical mobile phase.

To find the optimum value:

Start at 5 μA and increase **Corona (uA)** in 2 μA steps until the optimum is found, allowing the current to stabilize for each step before taking a reading.

If the signal continuously decreases, select the Tune Page Menu Bar **Options, Voltage Mode** and optimize the corona voltage instead of corona current.

Probe Position

The in/out position of the APcI probe generally has little effect on sensitivity. The sideways adjustment can have a significant effect upon sensitivity.

Using the sideways adjuster, ensure that the spray is directed approximately at the mid-point between the corona pin and the sample cone.

This position occurs five full turns away from the stop closest to the corona pin.

Adjust the probe position around this point, one turn at a time, to optimize the signal.

Probe Temperature

It is important to optimize **APcI Probe Temp** (°C) for maximum sensitivity, as follows:

Ensure that the analytical mobile phase is used during optimization.

Starting at 700 °C (the maximum set temperature), reduce the temperature in 50 °C steps, allowing time for the temperature to stabilize for each step before taking a reading.

It is possible to set **APcI Probe Temp** (°C) too low for the mobile phase. This often results in significant chromatographic peak tailing.

Support Gas

This helps to support the nebulisation processes and aids sample flow through the probe. Adjustment of the support gas flow can influence the signal obtained; typically, a dial setting of 1.0 is used.

Desolvation Gas

In most circumstances, the desolvation gas flow has little effect on signal intensity. However, in some situations, it has been observed to have an effect on chemical background noise levels. Adjusting **Desolvation Gas** while acquiring in the MRM mode can be used as a check for this.

7.6 Removing the Probe

After a session of APcI operation:

Turn off the LC flow.

On the Tune Page, set **APcI Probe Temp** (°C) to 20 °C.

Select the  button.

When the probe temperature falls below 100 °C: Select the Tune Page **Gas, Gas** command to turn off the nitrogen.



Warning: Take care when removing the APcI probe; there is a risk of burns to the operator.



Caution: Removal of the APcI probe when hot shortens the life of the probe heater.

Undo the two thumbscrews and remove the probe from the source.

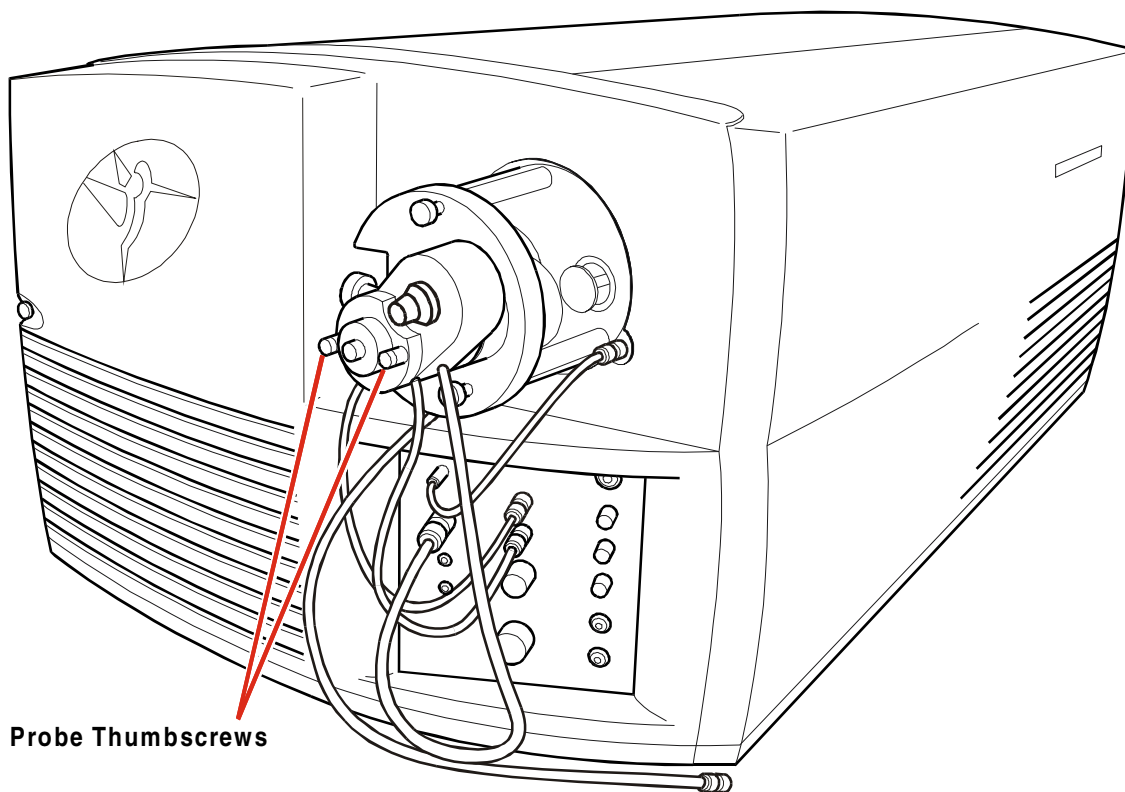

Figure 7-4 Probe Removal from Source

If the instrument is not to be used for a long period, reduce **Source Temp** (°C) to 60 °C.

Chapter 8

Maintenance and Fault Finding

8.1 Introduction



Warning: Many of the procedures described in this chapter involve the removal of possibly toxic contaminating deposits using flammable or caustic agents. Personnel performing these operations should be aware of the inherent risks, and should take the necessary precautions.

Cleanliness and care are of the utmost importance whenever internal assemblies are removed from the instrument.

- Always prepare a clear clean area in which to work.
- Make sure that any tools or spare parts that may be required are nearby.
- Obtain some small containers in which screws, washers, spacers, etc. can be stored.
- Use tweezers and pliers whenever possible.
- If nylon or cotton gloves are used, take care not to leave fibers in sensitive areas.
- Avoid touching sensitive parts with fingers.
- Do not use rubber gloves.
- Before reassembling and replacing dismantled components, inspect O-rings and other vacuum seals for damage. Replace with new if in doubt.

Should a fault occur soon after a particular part of the system has been repaired, or otherwise disturbed, it is advisable to ensure that this part has been correctly refitted and/or adjusted. Also check that adjacent components have not been inadvertently disturbed.

8.2 Cooling Fans and Air Filters

Always ensure that none of the cooling fans is obstructed. It is essential that the fan filter is checked at regular intervals, and replaced if there is any doubt about its effectiveness.

8.3 The Vacuum System

The performance of the mass spectrometer is severely impaired by the lack of a good vacuum in the ion transfer (ion tunnel) regions or the analyzer.

- An analyzer pressure above 10^{-4} mbar results in a general loss in performance indicated by a loss of resolution and an increase in the background noise.
- Above 10^{-3} mbar the **Operate** and **Vacuum** LEDs on the instrument change from green to amber, indicating that the vacuum is insufficient to maintain the instrument in operate.
- Above 10^{-2} mbar the **Vacuum** LED changes to flashing red, indicating that the vacuum pump trips have been activated, followed by no indication when the instrument is no longer pumping.

Before suspecting a leak, the following points should be noted:

- The turbomolecular pumps do not operate if the rotary pump has failed.
- If the rotary pump is not maintained, the oil may become so contaminated that optimum pumping speed is no longer possible. Initially, gas ballasting may clean the oil. If the oil in the rotary pump has become discolored, then it should be changed according to the pump manufacturer's maintenance manual.
- The turbomolecular pumps switch off if an over temperature is detected. This could be due to poor backing vacuum, failure of the water supply or a leak in the source or analyzer.
- The turbomolecular pumps switch off if full speed is not achieved within a set time following start-up. This could be due to a leak or too high an ambient temperature.

8.3.1 Vacuum Leaks

If a leak is suspected, the following basic points may help to locate it:

- Leaks very rarely develop on an instrument that has been fully operational. Suspect components that have recently been disturbed.

Leaks on flanges can usually be cured by further tightening of the flange bolts or by replacing the seal.

- All seals are made using O-rings. When refitting flanges pay attention to the condition of O-rings. Any that are cut or marked may cause a leak. The O-rings should be clean and free from foreign matter.

A hair across an O-ring is sufficient to prevent the instrument pumping down.

- Source components that operate at, or slightly above, atmospheric pressure are not susceptible to vacuum leaks.

In the unlikely event of a leak on a feedthrough, then the unit should be replaced, or returned to Micromass for repair.

8.3.2 Pirani Gauge

The Pirani gauge head does not require routine maintenance.

8.3.3 Active Inverted Magnetron Gauge

For information on cleaning the active inverted magnetron (Penning) gauge, refer to the Edwards literature supplied with the instrument.

8.3.4 Gas Ballasting and Rotary Pump Oil Recirculation

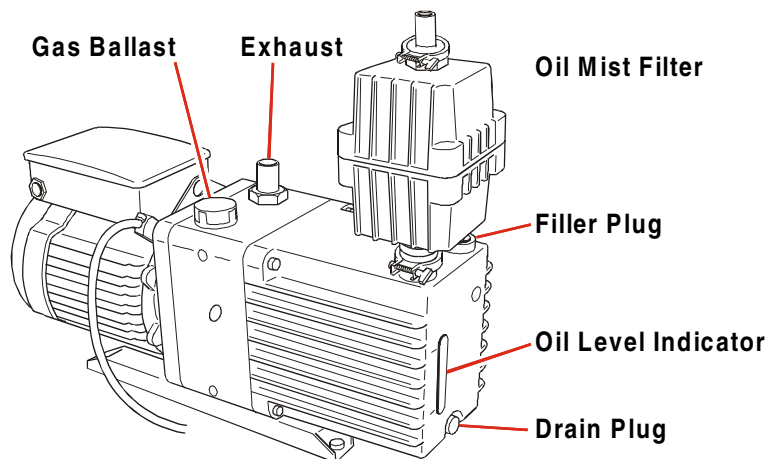

Figure 8-1 Rotary Pump Maintenance

Gas ballasting serves two important purposes:

- When rotary pumps are used to pump away solvent vapors, the solvent vapor can become dissolved in the pump oil causing an increase in backing line pressure. Gas ballasting is a method of purging the oil to remove dissolved contaminants.
- Oil mist expelled from the rotary pump exhaust is trapped in the oil mist filter. This oil is returned to the rotary pump during gas ballasting.



Caution: Failure to gas ballast the rotary pump frequently leads to shortened oil lifetime which, in turn, may shorten rotary pump lifetime.



Caution: The instrument should not be vented with the E2M28 manual gas valve open. The E1M18 manual gas ballast valve should remain open at all times.

The Quattro Ultima Pt has two rotary pumps; an E1M18 pumping the source block and an E2M28 pumping the first ion tunnel. Because the source block is maintained at a relatively high pressure, the rate of oil mist being expelled from the E1M18 pump is considerably higher than that from the E2M28 pump. Consequently, it is recommended that the E1M18 pump is operated continuously in gas ballast mode so that the pump oil is continuously recirculated.

Continual operation in gas ballast mode is not usually recommended as venting of the instrument whilst rotary pumps are ballasting can cause oil vapor to migrate into the vacuum housing. However, the E1M18 has an additional automatic gas ballast control valve mounted in the oil return line from the mist filter. This valve is opened whenever the E1M18 is switched on, allowing continuous recirculation of the pump oil provided that the manual gas ballast valve on the pump is left open.

In the event of a vent command or automatic vent (vacuum fault or power failure) the pump is switched off and the automatic gas ballast valve closes thus preventing any contamination of the vacuum housing.

The E2M28 rotary pump is not equipped with an automatic gas ballast control valve, and this pump should normally be operated with the manual gas ballast valve closed. The valve should only be opened for 30 minutes each week to perform routine gas ballasting of the pump. If the source is used in the APcI or MegaFlow ElectroSpray modes, more frequent gas ballasting is recommended.

The manual gas ballast valve is opened by rotating it fully counterclockwise.

It is normal for the rotary pump to make more noise when the gas ballast valve is open.

8.3.5 Oil Mist Filter

The rotary pumps are fitted with an Edwards EMF20 oil mist filter which traps oil vapor from the rotary pump exhaust. The trapped oil is then returned to the rotary pump during routine gas ballasting. The oil mist filter contains two elements that require the following maintenance:

- Change the odor element monthly, or whenever the pump emits an oily odor.
- Change the mist element every time the rotary pump oil is changed.

To change the elements, follow the instructions in the Edwards manual.

8.3.6 Foreline Trap

The foreline trap stops oil vapor migrating from the rotary pump to the mass spectrometer. During normal use, the activated alumina (sorber) absorbs any oil vapor, becoming brown in color. The sorber should be replaced when this discoloration reaches the region of the trap furthest from the pump (the vacuum side). The manufacturers recommend that the sorber is replaced routinely at three-monthly intervals.

With the instrument vented and the pump switched off, replace the sorbent as described in the manufacturer's literature.

8.3.7 Rotary Pump Oil

The oil in the rotary pump should be maintained at the correct level at all times. Check the oil level at weekly intervals, topping up if necessary.

It is important to monitor the condition of the oil regularly. Replace the oil when it has changed to a noticeable red color, or routinely at 4 month intervals (3000 hours operation). At the same time, replace the oil mist filter's mist element (see above).

Change the oil in the rotary pump as follows:

Gas ballast lightly for 30 to 60 minutes.

Close the gas ballast valve.

Vent and shut down the instrument as described in the *Routine Procedures* section.

It is easier to drain the oil while the pump is still warm.

Drain the oil through the drain hole situated near the oil level sight glass.

Flush the pump, then refit the drain plug, and refill the pump with the correct grade oil to the correct level.

Gas ballast lightly for 30 to 60 minutes.

For further servicing information refer to the manufacturer's manual.

8.4 The Source

8.4.1 Overview



Warning: Cleaning the various parts of the source requires the use of solvents and chemicals that may be flammable and hazardous to health. The user should take all necessary precautions.

The Z-spray source is a robust assembly requiring little maintenance. The source consists of three basic parts:

- The probe adjustment flange.
- The glass tube.
- The source flange assembly.

The probe adjustment flange and the glass tube can be readily removed, without venting the instrument, to gain access to the source block and sample cone. This allows the following operations to be performed:

- Removing the cone gas nozzle and sample cone.
- Fitting or removing the APcI discharge pin.
- Fitting or removing the exhaust liner and cleanable baffle.
- Fitting or removing the NanoFlow ElectroSpray interface.
- Enabling or disabling the purge gas.

Cleaning of the sample cone and cone gas nozzle may be achieved by removing them from the source. This may also be done without venting the instrument, by closing the isolation valve located on the ion block. Less frequently, it may be necessary to clean the ion block and the first ion tunnel, in which case the instrument must be vented. This should only be done when the problem is not rectified by cleaning the sample cone and cone gas nozzle, or when charging effects are apparent.

Charging is evidenced by a noticeable progressive drop in signal intensity, often resulting in a complete loss of signal. Switching the instrument out of and back into operate causes the beam momentarily to return.

The first ion tunnel should not require frequent cleaning. If it is suspected that cleaning is required, the ion tunnel may be withdrawn from the front of the instrument after removing the ion block support.

8.4.2 Cleaning the Cone Gas Nozzle and Sample Cone

This may be necessary due to lack of sensitivity or fluctuating peak intensity, or if deposited material is visible on the outside of the nozzle or sample cone. Proceed as follows:

Select the MassLynx Window **Instrument** Shortcut Bar MS Tune icon,  to invoke the tune page.

Select the  button.

Switch off the LC pumps.

Disconnect the liquid flow at the rear of the probe.

Set **Source Temp** and either **APCI Probe Temp** or **Desolvation Temp** to 20 °C to switch off the heaters.

Warning: Removal of the APCI probe or desolvation nozzle when hot may cause burns.



Caution: Removal of the APCI probe when hot shortens the probe heater's life.



The cooling time is significantly shortened if the API gases are left flowing.

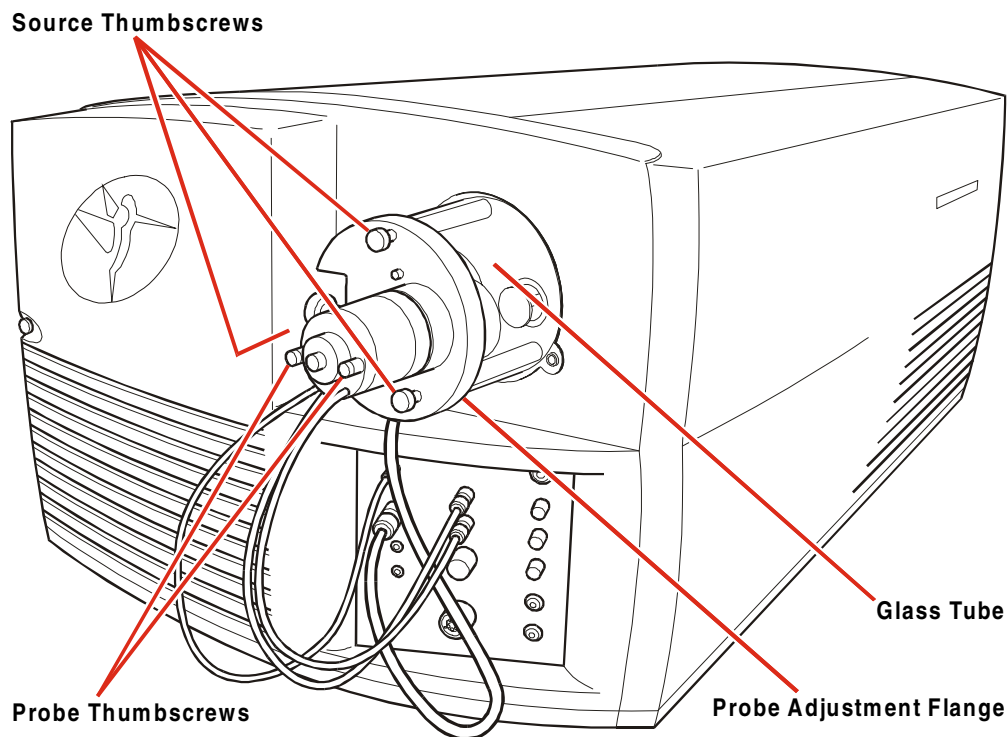

Figure 8-2 Source Dismantling for Sample Cone Access

When the **APCI Probe Temp (°C)** or **Desolvation Temp (°C)** has cooled below 100 °C:

Switch off the nitrogen supply by selecting the Tune Page Menu Bar **Gas, Gas** command.

Disconnect both gas lines from the front panel.

Disconnect both electrical connections.

Unscrew the probe thumbscrews that retain the probe (2-off) and withdraw the probe from the source. Place it carefully to one side.



Warning: The source block is exposed when the source enclosure has been removed. Ensure that the source block heater has cooled before proceeding.

Undo the source thumbscrews (3-off) and withdraw the probe adjustment flange and glass tube. Place the glass tube, end on, on a flat surface and place the probe adjustment flange on top of the glass tube.

If fitted, remove the APcI discharge pin.

The sample cone and cone gas nozzle are now accessible.

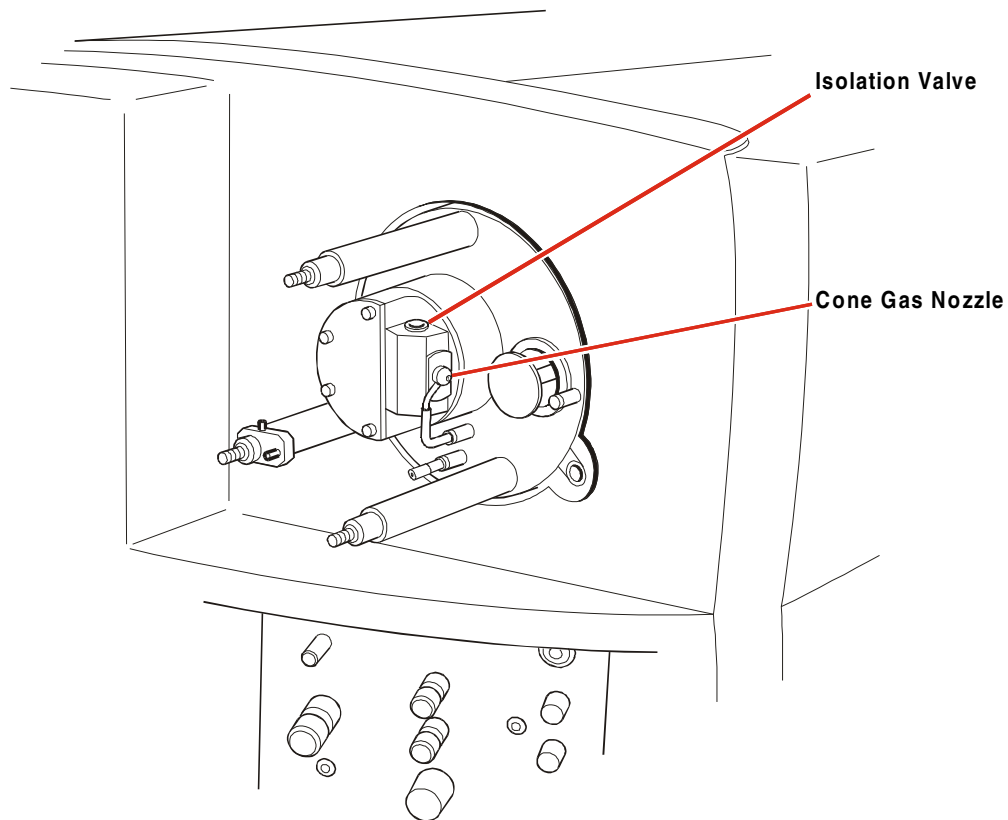

Figure 8-3 Sample Cone and Gas Nozzle

Using a suitable flat blade screwdriver, rotate the isolation valve by 90° into its fully counterclockwise position.

A small improvement in the analyzer vacuum may be observed as a result of this operation.

The isolation valve is closed when the slot is perpendicular to the direction of flow.

Disconnect the cone gas inlet line.



Caution: The sample cone is a delicate and expensive component; it should be handled with extreme care.

Screw the sample cone extraction tool (supplied in the source spares kit) to the sample cone flange.

Remove the sample cone retaining screws (2-off) using a 1.5 mm Allen key and withdraw the sample cone, gasket and cone gas nozzle from the ion block.

Remove the sample cone extraction tool, and separate the sample cone, the gasket, and the cone gas nozzle.



Caution: Do not attempt to remove any obstruction by poking. This may result in damage to the sample cone.

Carefully wipe the sample cone and cone gas nozzle with a cotton swab or lint free tissue soaked in 50:50 acetonitrile:water or 50:50 methanol:water.

If the components are still not clean, or if the aperture is partially blocked, place the components in an ultrasonic bath containing 50:50 acetonitrile:water or 50:50 methanol:water.

To minimize down time, fit a spare sample cone and cone gas nozzle, obtainable from Micromass, at this stage.

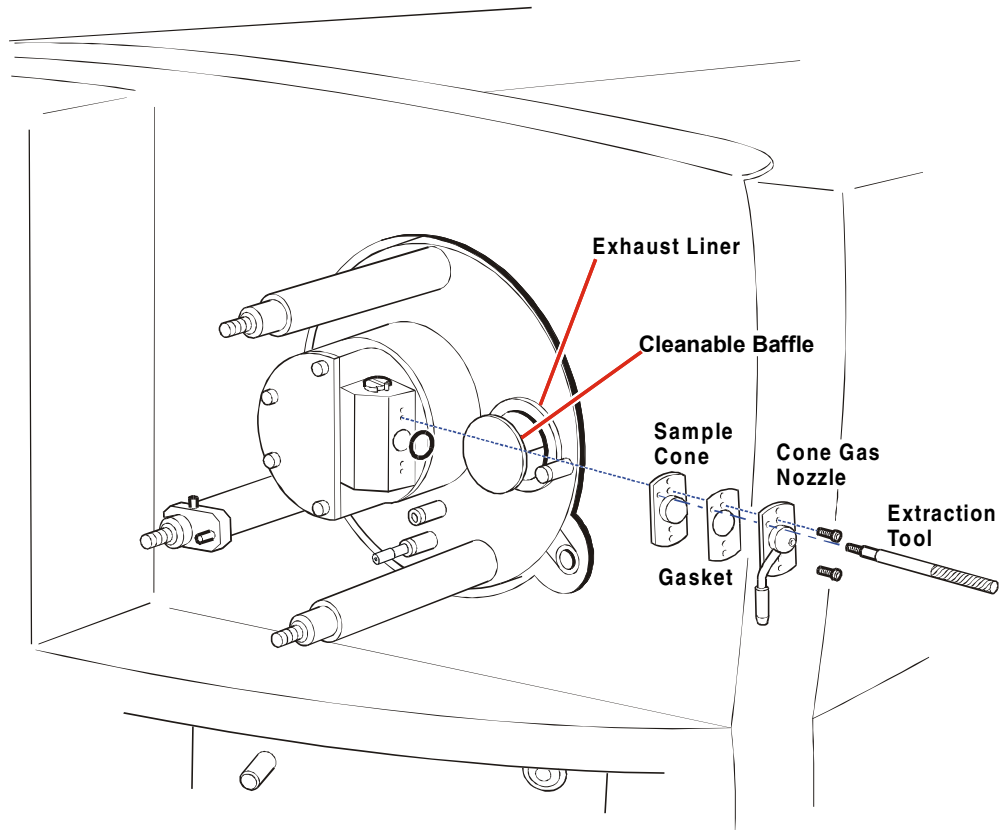

Figure 8-4 Sample Cone Removal

Dry the cone and nozzle using nitrogen.

If material has built up on the exhaust liner and cleanable baffle:

Remove the cleanable baffle and the exhaust liner.

Clean these components, or obtain replacements.

Fit the cleaned (or the replacement) exhaust liner and cleanable baffle to the ion block.

Refitting the sample cone and cone gas nozzle is a reversal of the removal procedure.

The source isolation valve is fully open when the screwdriver slot is parallel to the direction of gas flow. Note that the valve can be rotated past the fully open position.

8.4.3 Removing and Cleaning the Ion Block

Select the Tune Page Menu Bar **Options, Vent** command.

The rotary pump and the turbomolecular pumps switch off. The turbomolecular pumps are allowed to run down to 50% speed, after which a vent valve opens to atmosphere automatically.

Remove the source enclosure, sample cone and cone gas nozzle, as described in the previous section.

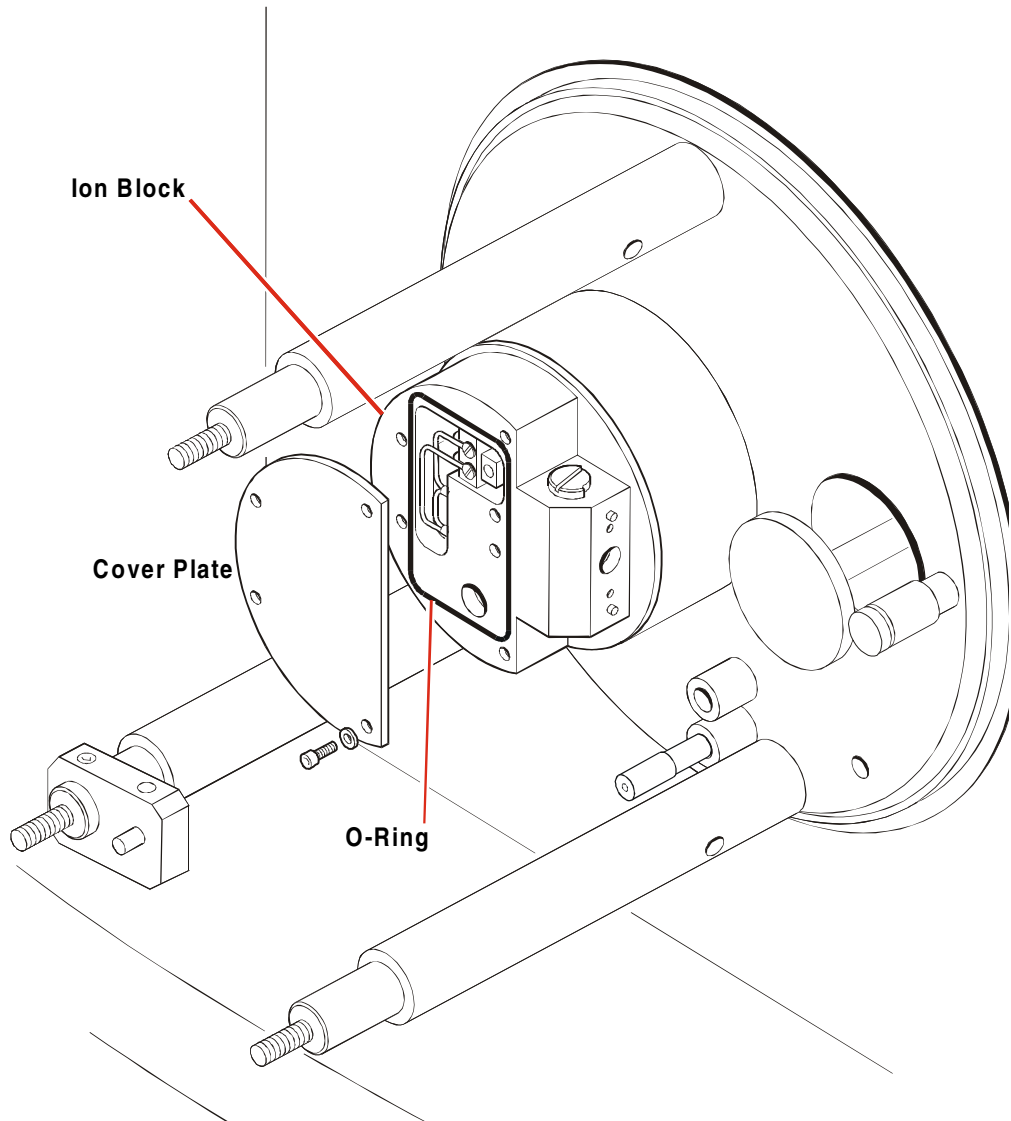

Figure 8-5 Ion Block Cover Plate



Warning: The heater supply remains live until the system is fully vented. Do not remove the cover plate until the system has vented.

When the instrument has vented:

Remove the four screws, together with the washers, which secure the cover plate to the ion block and remove the cover plate.

Ensure that the O-ring remains in position on the ion block.

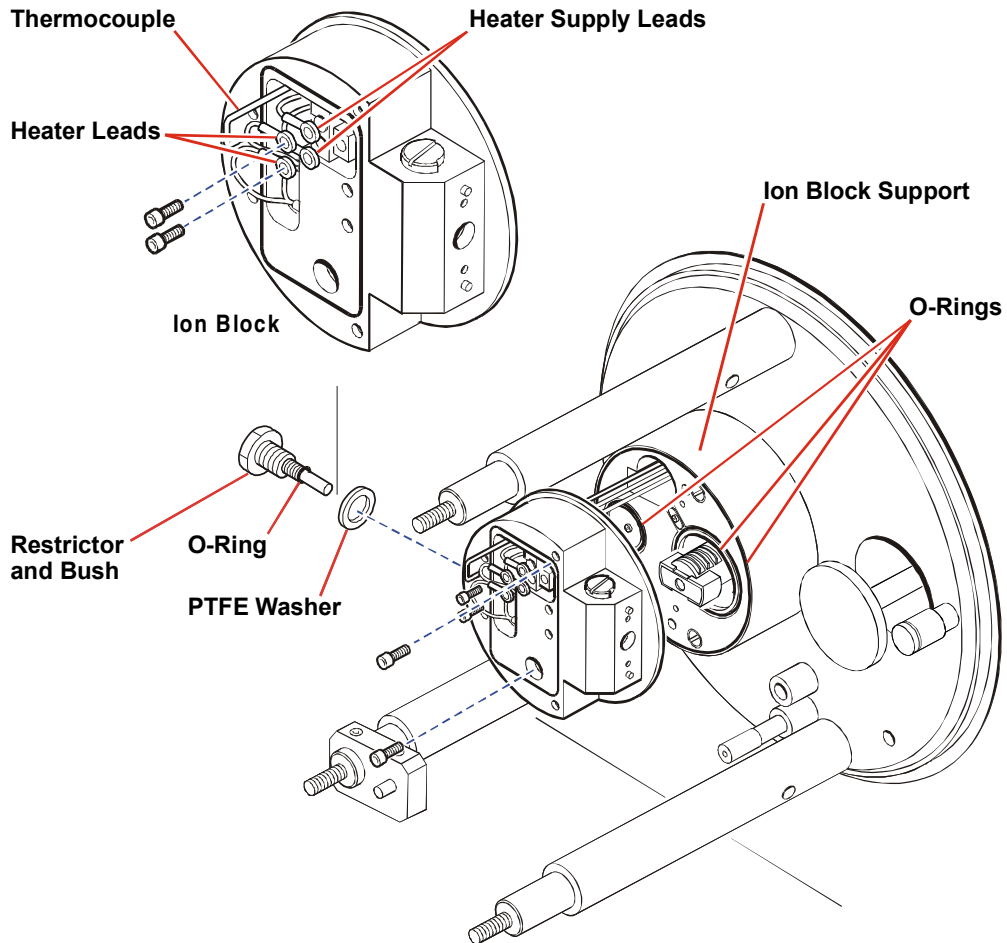

Figure 8-6 Ion Block Removal

Remove the two screws from the heater connections on the ion block.

Carefully straighten the heater supply leads, in such a way that the ion block can later be withdrawn without fouling these leads.

Loosen the screw on the thermocouple's securing clip and unhook the thermocouple from its location.

Remove the two screws that secure the ion block to the ion block support.

Withdraw the ion block, leaving the thermocouple and heater supply leads protruding from the ion block support.

Ensure that the three O-rings remain in position on the ion block support.

Unscrew the restrictor's outer bush from the ion block, taking care not to disturb the setting of the inner restrictor. Collect the PTFE washer, and ensure that the O-ring remains in position on the restrictor shaft.

Wipe the inner end of the restrictor with a cotton swab or lint free tissue soaked in 50:50 acetonitrile:water or 50:50 methanol:water, to remove any carbon deposits.

Leaving the heater, valve, thermocouple clip and terminal block in place, immerse the ion block in an ultrasonic bath containing 50:50 acetonitrile:water or 50:50 methanol:water, followed by 100% methanol.

Dry all components using a flow of nitrogen, or place them in a warm oven.

8.4.4 Removing and Cleaning the Ion Tunnel Assembly

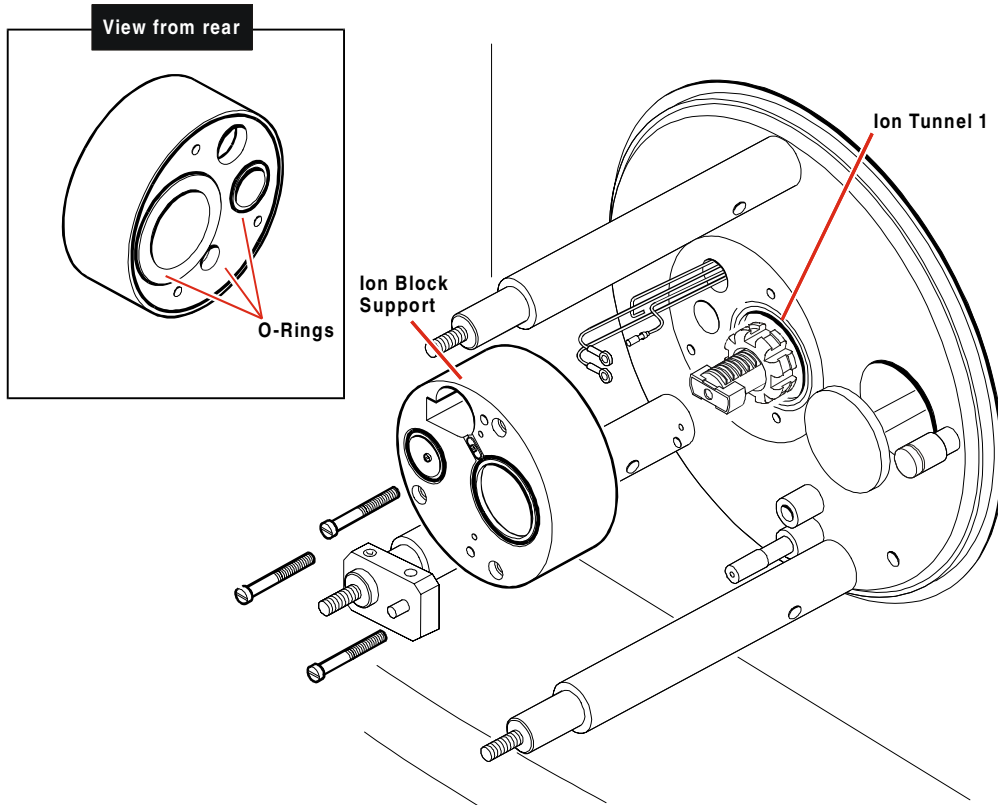

Figure 8-7 Removing and Cleaning Ion Block Assembly

To remove the ion tunnel assembly, proceed as follows:

Remove the ion block, as described above.

Remove the three screws retaining the ion block support and carefully withdraw it from the pumping block.

Note: Ensure that the three O-rings remain in position on the rear face of the support.



Caution: Take care not to scratch the internal bore of the pumping block, as the ion tunnel assembly is withdrawn.

Using a lint-free tissue to gently grasp the ion tunnel, carefully withdraw it.

Note: Ensure that the O-ring remains correctly located on the differential aperture plate.

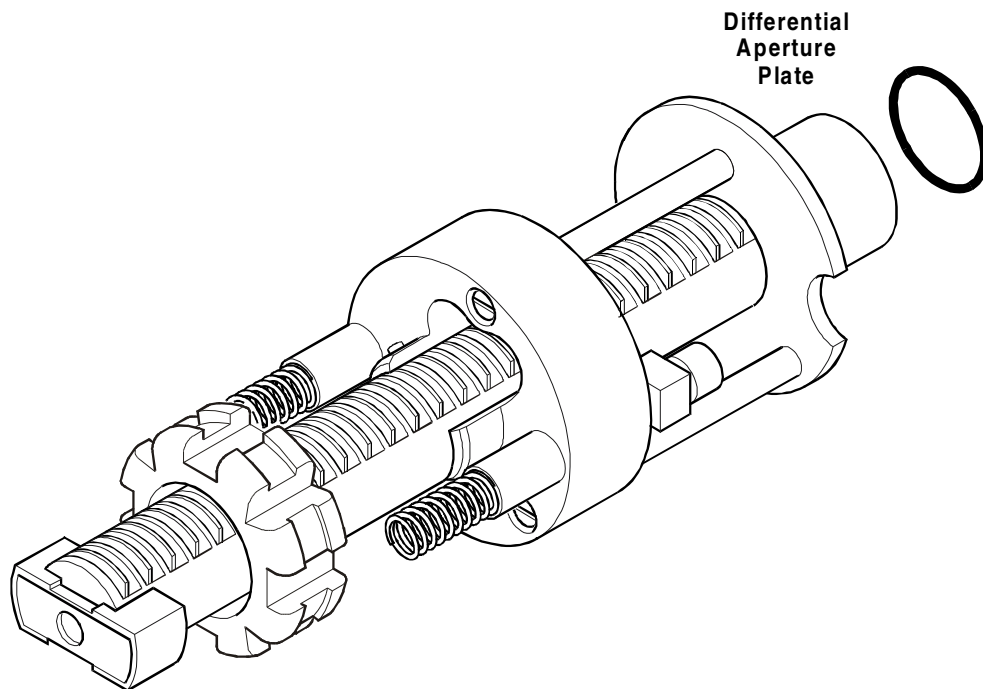

Figure 8-8 Differential Aperture Plate O-Ring

To clean the ion tunnel proceed as follows:

Immerse the complete assembly in a suitable solvent (100% methanol) and sonicate in an ultrasonic bath.

Thoroughly dry the assembly using a flow of nitrogen.

In severe cases:

Remove the differential aperture plate and clean thoroughly. A glass fiber pencil can be used to remove burn marks around the aperture.

Clean the component in an ultrasonic bath.

Do not disassemble the ion tunnel. Cleaning the tunnel should be carried out with great care using the wire brush provided.

Gently insert the brush into the aperture and use a rotary motion to clean the apertures. Take great care not to bend the plates on the tunnel. A glass fiber pencil can be used to remove burn marks on the entrance and exit plates.

Subsequently clean the tunnel in an ultrasonic bath as above, ensuring that no fibers from the brush remain.

Reassemble the differential aperture.

8.4.5 Reassembling and Checking the Source

Check the condition of all O-rings. Replace them if necessary.

With the two springs in a horizontal plane, feed the ion tunnel transfer lens into the instrument. Ensure that the O-ring is correctly fitted to the differential aperture plate, and that the assembly is pushed fully in.

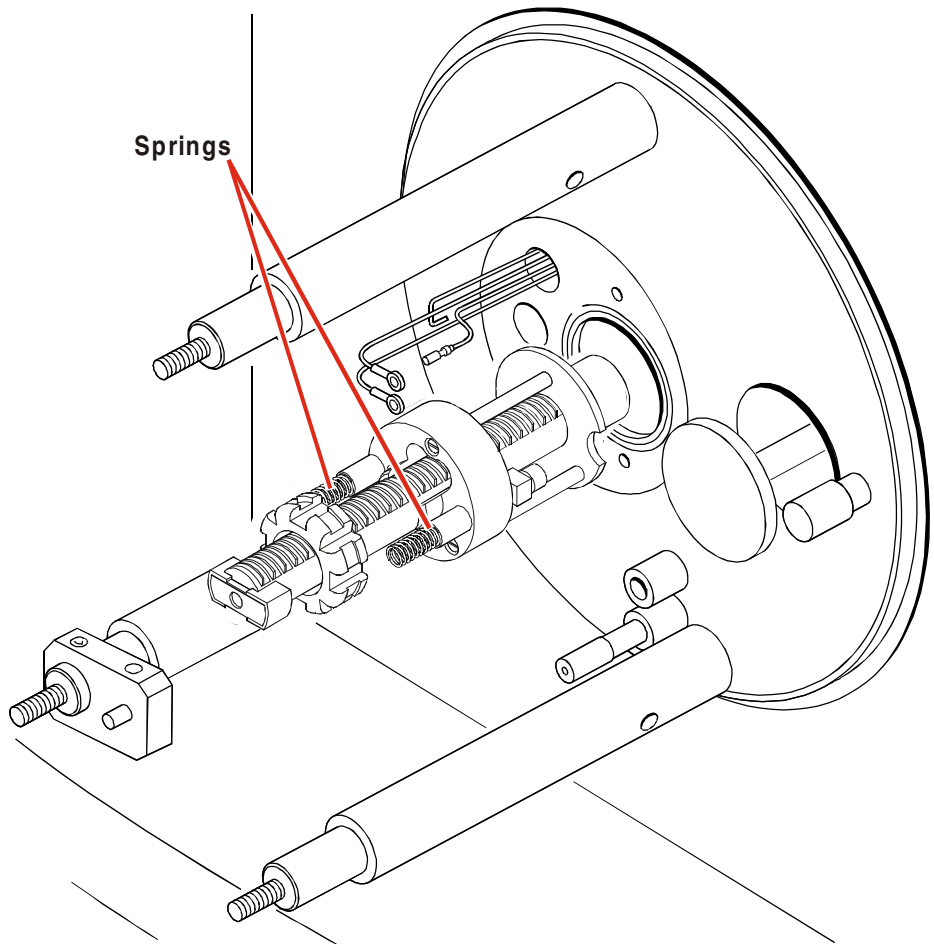

Figure 8-9 Ion Tunnel Assembly Springs

Refit the ion block support, pushing it in against the ion tunnel assembly springs.

Refit the three retaining screws.

Refit the restrictor and bush, complete with O-ring and PTFE washer, on the ion block.

Locate the ion block on the peek ion block support, and secure with the two screws taking care not to over-tighten the screws.

Insert the thermocouple into its location, and secure it with the clip.

Reconnect the heater leads and heater supply leads to the terminal block, carefully bending the supply leads as necessary.

Refit the cover plate.

Check that the isolation valve is closed.

Select the Tune Page Menu Bar **Options, Pump** command.

Refit the PTFE exhaust liner and cleanable baffle, if removed.

Refit the sample cone, gasket and sample cone nozzle on the ion block.

Reconnect the cone gas supply.

When the instrument has pumped down:

Open the isolation valve.

Fit the APcI corona discharge pin or blanking plug, as necessary.

Fit the source enclosure and the probe adjustment flange.

8.4.6 The Corona Discharge Pin

If the corona discharge pin becomes dirty, or blunt:

Remove it from the source.

Clean and sharpen it using 600 grade emery paper.

The needle should be renewed if it becomes bent or otherwise damaged.

8.5 The ElectroSpray Probe

8.5.1 Overview

Indications that maintenance is required to the ElectroSpray probe include:

- An unstable ion beam.

Nebulizing gas may be escaping from the sides of the probe tip.

Ensure that the probe tip O-ring is sealing correctly.

The probe tip setting may be incorrect.

Adjust the probe tip setting as described in the *ElectroSpray* section.

The probe tip may be damaged.

Refit the probe tip.

There may be a partial blockage of the sample capillary or the tubing in the solvent flow system.

Clear the blockage or replace the tubing.

- Excessive broadening of chromatogram peaks.

This may be due either to inappropriate chromatography conditions, or to large dead volumes in the transfer capillaries between the LC column or probe connection.

Ensure that all connections at the injector, the column, the splitting device (if used) and the probe are made correctly.

- High LC pump backpressure.

With no column in line, and the liquid flow set to 300 μ l/minimum, the backpressure should not exceed 7 bar (100 psi). Pressures in excess of this indicate a blockage in the solvent flow system.

Samples containing particulate matter, or those of high concentrations, are most likely to cause blockages.

Check for blockages at the tube connections and couplings to the injector, the column and, if used, the flow splitter.

Concentrated formic acid can be injected to clear blockages. Rinse thoroughly afterwards.

Blockage of the stainless steel sample capillary may occur if the desolvation heater is left on without liquid flow. This is particularly relevant for samples contained in involatile solvents or high analyte concentrations. To avoid this problem it is good practice to switch off the heater before stopping the liquid flow, and flush the capillary with solvent.

A blocked stainless steel sample capillary can often be cleared by removing it and reconnecting it in the reverse direction, thus flushing out the blockage.

- Gas flow problems

Check all gas connections for leaks using soap solution, or a suitable leak searching agent such as Snoop.

8.5.2 Renewal of the Stainless Steel Sample Capillary

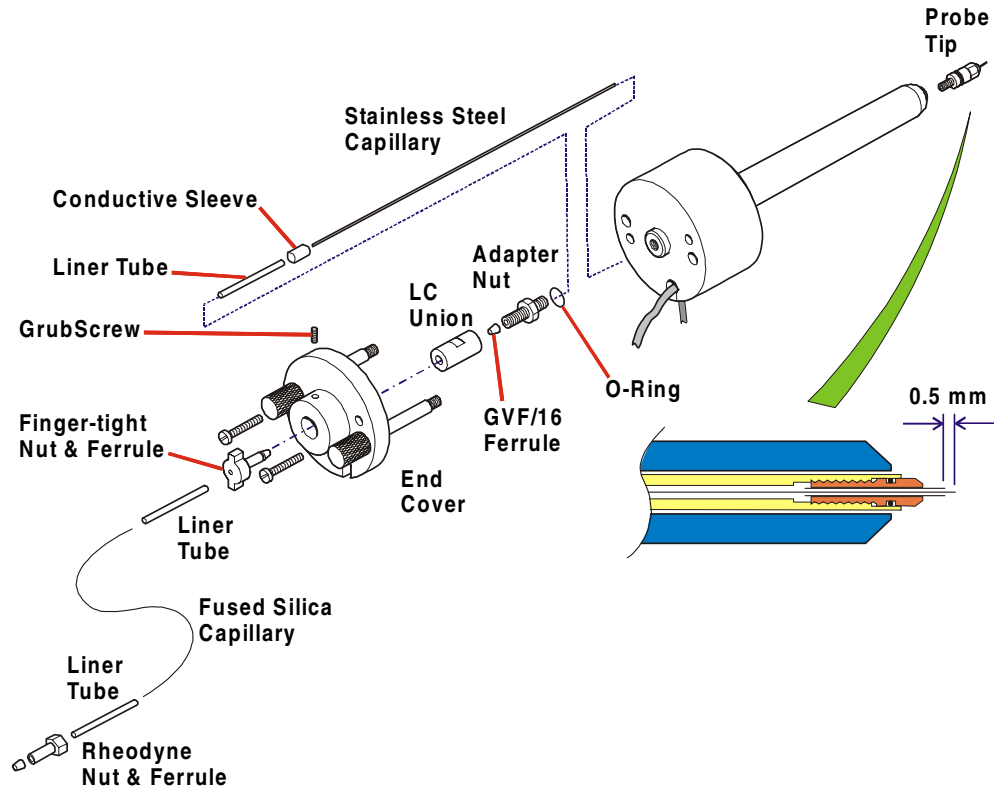

Figure 8-10 Renewal of Stainless Steel Sample Capillary

If the stainless steel sample capillary cannot be cleared, or if it is contaminated or damaged, replace it as follows:

Remove the probe from the source.

Disconnect the LC line from the probe and remove the finger-tight nut.

Loosen the grub screw retaining the LC union.

Remove the probe end cover retaining screws (2-off), and remove the probe end cover.

Unscrew and remove the probe tip.

Remove the LC union and adapter nut. Withdraw and discard the stainless steel sample capillary.

Remake the LC connection to the LC union.

Sleeve one end of new sample capillary with the PTFE liner tube.

Using a GVF/16 ferrule and the adapter nut, connect the sample capillary to the LC union, ensuring that both the liner tube and sample capillary are fully butted into the LC union.

Disconnect the LC connection and feed the sample capillary through the probe, ensuring that the conductive sleeve is fitted.

Using a Rheodyne spanner, gently tighten the adapter nut onto the probe.

Refit the probe tip and adjust so that 0.5 mm of sample capillary protrudes from the probe tip.

Refit the probe end cover and tighten the grub screw to clamp the LC union.

8.6 The APcI Probe

Indications that maintenance to the APcI probe is required include:

- The probe tip assembly becomes contaminated, for example by involatile samples if the probe temperature is too low during operation (300 °C).
- The appearance of chromatogram peak broadening or tailing.

Samples that give rise to a good chromatogram peak shape in APcI (for example reserpine and common pesticides) should display peak half widths of the order 0.1 minutes for 10 µl loop injections at a flow rate of 1 ml/min. The appearance of significant peak broadening or tailing with these compounds is most likely to be due to a broken fused silica capillary or probe tip heater assembly.

- Low LC pump backpressure.

For 50:50 acetonitrile:water at a flow rate of 1 ml/min, a LC pump back pressure less than 14 bar (200 psi) is indicative of a broken fused silica capillary or a leaking connector.

- High LC pump backpressure.

*For 50:50 acetonitrile:water at a flow rate of 1 ml/min, a LC pump back pressure above 35 bar (500 psi) is indicative of a blockage or partial blockage in the fused silica capillary, in a LC connector or in the filter. It is advisable to change the inner filter pad (see the *Renewing the Fused Silica Capillary* section) on a regular basis.*

- Gas flow problems.

Check all gas connections for leaks using soap solution, or a suitable leak-searching agent such as Snoop.

8.6.1 Cleaning the Probe Tip

Remove any visible deposits on the inner wall of the probe heater with a nylon tube brush (supplied in the spares kit) soaked in methanol:water.

Before starting an analysis:

With the probe out of the instrument, connect the nebulising gas supply line.

Select the Tune Page Menu Bar **Gas**, **Gas** command to turn on the nitrogen.

Allow the gas to flow for several seconds to clear any debris from the heater.

Select the Tune Page Menu Bar **Gas, Gas** command to turn off the nitrogen.

Insert the probe into the source.

Select the Tune Page Menu Bar **Gas, Gas** command to turn on the nitrogen.



Caution: Do not set **APci Probe Temp** (°C) to 700 °C immediately, as this may damage the probe heater.

Raise **APci Probe Temp** (°C) gradually, starting at 100 °C and increasing in 50 °C intervals to 700 °C over a period of 10 minutes.

This procedure should remove any chemical contamination from the probe tip.

8.6.2 Renewing the Probe Tip Heater

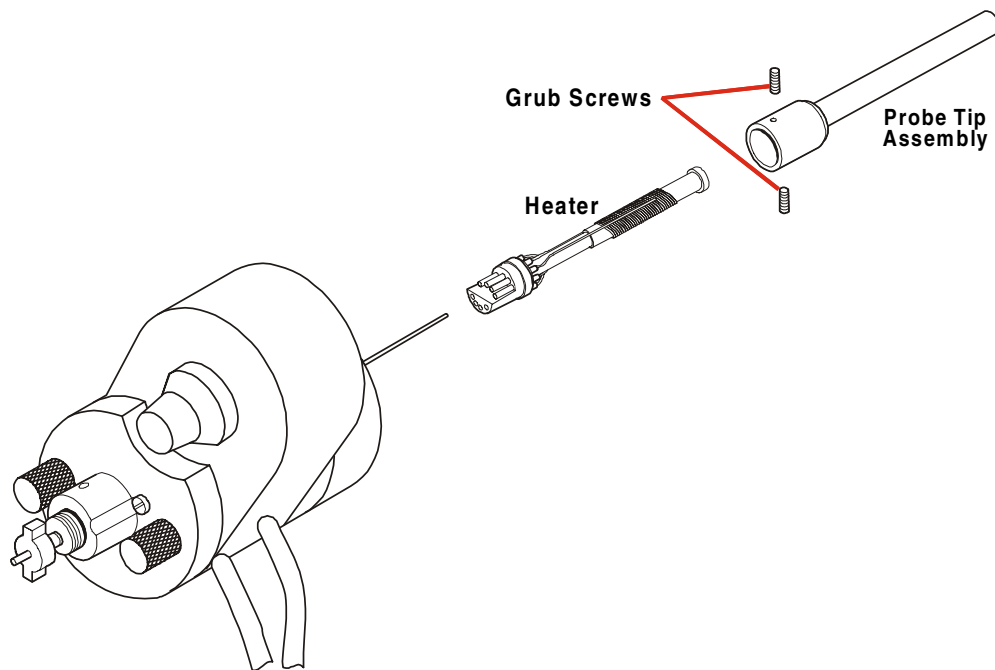

Figure 8-11 Renewing the Probe Tip Heater

Remove the probe tip assembly after carefully loosening the two grub screws.

Disconnect the heater from the probe body by pulling parallel to the axis of the probe.

Fit a new heater assembly.

Reconnect the probe tip assembly.

8.6.3 Renewing the Fused Silica Capillary

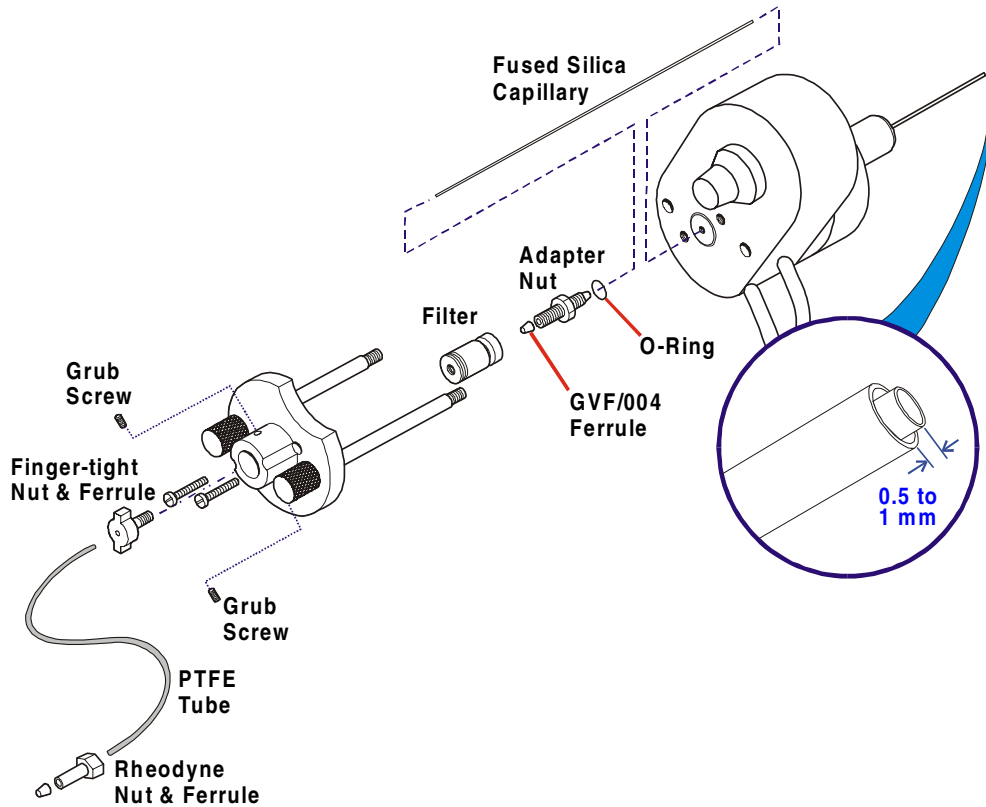

Figure 8-12 Renewing the Fused Silica Capillary

With the probe removed from the source, proceed as follows:

Remove the probe tip assembly and the heater, as described in the preceding section.

Remove the probe end cover by removing the two screws and the grub screw that retains the LC filter.

Loosen the filter from the adapter nut.

Unscrew the adapter nut from the probe.

Remove and discard the fused silica capillary.

Using a ceramic capillary cutter, cut a new length of 300 μm o.d. \times 100 μm i.d. fused silica capillary, about 10 mm excess in length.

Using a GVF/004 ferrule and the adapter nut, connect the sample capillary to the filter ensuring that the liner tube is fully butted into the filter.

Using a ceramic capillary cutter, cut the capillary at the nebuliser so that between 0.5 and 1.0 mm of capillary is protruding from the nebuliser.

It is important to cut the capillary square. This should be examined using a suitable magnifying glass.

Undo the adapter nut from the probe and withdraw the capillary from the probe.

Use a flame to remove 20 mm of polyamide coating from the end of the capillary, and clean with a tissue saturated with methanol.

Carefully re-feed the sample capillary through the probe.

Using a Rheodyne spanner, gently tighten the adapter nut to the probe.

Refit the probe end cover and retaining screws.

Using a 1.5 mm Allen key, tighten the grub screw in the probe end cover to clamp the filter.

Carefully refit the heater and probe tip assembly.

8.7 The Analyzer

Quattro Ultima Pt is fitted with a pre-filter assembly that is designed to protect the main analyzer by absorbing contamination from the ion beam. Consequently, the analyzer quadrupoles should never require cleaning under normal working conditions.

The ion tunnel transfer lens also serves to effectively remove contamination, and the pre-filter assembly should only require cleaning on an infrequent basis. Although training is given during installation, it is strongly recommended that this task is carried out by a Micromass service engineer or by other suitably qualified personnel.

The quadrupole assemblies of Quattro Ultima Pt are finely machined and aligned assemblies which *under no circumstances* should be dismantled.

8.8 The Detector

The Quattro Ultima Pt detector system has been designed for trouble-free operation over many years. The photomultiplier is encapsulated in its own vacuum envelope and is therefore safe from contamination and pressure surges. The conversion dynode and phosphor are also long lasting. No routine maintenance is required.

It is strongly recommended that assistance is sought from Micromass if maintenance to the detector system is thought necessary due to spikes or unacceptably high noise levels.

8.9 Electronics



Warning: There are high voltages present throughout the mass spectrometer. Extreme caution should be taken when taking measurements with a meter or an oscilloscope. In the standby mode (**Operate** not selected) the high voltages are switched off in the source and analyzer assemblies, but high d.c. voltages and mains voltages remain in the power supply units.



Caution: The Quattro Ultima Pt instrument's electronic systems contain complex and extremely sensitive components. Any fault-finding procedures should be carried out only by Micromass engineers.

8.9.4 Fuses

In the following list, the designation "T" indicates a time lag fuse.

Analog PCB

Fuse No.	Fuse Type	Ref. No.
F1	10 A (T) 20 mm anti-surge TDS505	1340143
F2	10 A (T) 20 mm anti-surge TDS505	1340143

RF Power PCB

Fuse No.	Fuse Type	Ref. No.
F1	5 A (T) 20 mm anti-surge	1340142

Power Backplane #2

Fuse No.	Fuse Type	Ref. No.
F7	2 A (T) 20 mm anti-surge TDS506	1340161
F8	2 A (T) 20 mm anti-surge TDS506	1340161

Pumping Logic PCB

Fuse No.	Fuse Type	Ref. No.
F1	2 A (T) 20 mm semi-delay	1340137

Power Sequence PCB

Fuse No.	Fuse Type	Ref. No.
F1	4 A (T) 20 mm anti-surge ceramic	1340164
F2	2 A (T) 20 mm anti-surge TDS506	1340161
F3	6.3 A (T) 20 mm anti-surge TDS506	1340163

Rear Panel

Fuse No.	Fuse Type	Ref. No.
F1	10 A (T) HBC anti-surge ceramic	1340147
F2	10 A (T) HBC anti-surge ceramic	1340147

Slew Limited Relay Unit

Fuse No.	Fuse Type	Ref. No.
F1	10 A (T) HBC anti-surge ceramic	1340147

Mains Terminal Block

Fuse No.	Fuse Type	Ref. No.
F1	1 A (F) 20 mm glass	1340153

8.10 Fault Finding Check List



Warning: There are high voltages present throughout the mass spectrometer. Extreme caution should be taken when taking measurements with a meter or an oscilloscope. In the standby mode (**Operate** not selected) the high voltages are switched off in the source and analyzer assemblies, but high d.c. voltages and mains voltages remain in the power supply units.

Any investigation in the RF generator must be made only by a Micromass engineer.

8.10.1 No Beam

Refer to the relevant chapters of this manual and check the following:

- Normal tuning parameters are set and, where appropriate, read-back values are acceptable.
- All necessary cables have been correctly attached to the source and probe.
- **Operate** is on (check the LED on the front panel).
- The source has been assembled correctly and is clean.
- The source isolation valve is open.
- There are no error messages reported by the electronics (see the viewing window at the rear of the instrument).

8

8.10.2 Unsteady or Low Intensity Beam

Should the preceding checks fail to reveal the cause of the problem check that:

- Gas and liquid flows are normal.
- The analyzer pressure is less than 1×10^{-4} mbar.

8.10.3 Ripple

Peaks appear to vary cyclically in intensity when there is ripple superimposed on the peak. Possible causes are:

- Unstable power supplies in the source supplies or the RF/DC generator.
- Unstable photomultiplier supply.

- Vibration from the rotary pumps, or even other equipment in the same building.

The frequency of the ripple, measured using an oscilloscope, can often help locate the source. Mains frequency ripple, for example, points towards an unstable power supply or vibration from mains powered machinery.

8.10.4 High Noise Level in MRM Analyses

The background noise in MRM analyses can be either electronic or chemical. To distinguish between chemical noise and electronic noise, an acquisition should be performed with and without ions being transmitted to the detector. Ions are best prevented from reaching the detector by setting the ion energy 1 (MS1) and ion energy 2 (MS2) fully negative. If there is a significant decrease in the background noise with the ion energies set negative then the major contribution to the overall noise is chemical noise. Any residual noise is electronic noise.

If the dominant source of noise is chemical, a reduction in electronic noise does not yield significant improvements in overall signal to noise ratio.

Chemical Noise

The most common source of noise is chemical noise.

- If the auto injector, probe or connecting tubing have been exposed to a high concentration of the compound to be analyzed then this may be giving a high background due to “carry over”. This can occur if concentrations of a few ng/μl are used for tuning prior to attempting sub pg/μl detection levels. If the injector is contaminated the signal level normally changes when injections of mobile phase are made.

Repetitive injections of 10% formic acid and / or isopropanol may help reduce the noise. If the probe or connecting tubing are contaminated then infusing 10% formic acid and/or isopropanol with a syringe pump may help.

- Check that the LC system is not adding contaminants into the mobile phase.
Using a syringe pump, infuse a syringe of mobile phase taken from the solvent reservoir. Compare this with the MRM background when the LC system is delivering the solvent.
- Try a different MRM transition.

This may reduce the noise level if the compound(s) contributing to the chemical noise do not yield the same set of daughter ions as the compound being analyzed.

- Check the purity of solvents and additives.

Try a different type of solvent or the same type of solvent from a different manufacturer. Ensure all solvents and additives are HPLC grade. Check the cleanliness of any glassware used.

Electronic Noise

If the noise has been identified as electronic noise, the ion counting threshold level should be checked as follows:

Increase **Ion Counting Threshold** until the valleys of the peak-to-peak noise are brought down to the zero line. A value of 30 is typical.

It is not possible to give absolute values for typical peak-to-peak electronic noise, as this is dependent on detector gain and the dwell time used for the MRM experiment. However, the electronic noise should be fairly constant for a particular instrument, so a measurement made previously under the same MRM conditions (with ion energies negative) should provide a meaningful comparison to see if the electronic noise level has changed.

If, after checking the ion counting threshold as above, electronic noise is considered to be the dominant source of noise and has become significantly worse since instrument installation then further investigations should be carried out by a qualified Micromass engineer.

8.10.5 High Backpressure

For ElectroSpray, a higher than normal backpressure readout on the HPLC pump, together with a slowing of the actual solvent flow at the probe tip, can imply that there is a blockage in the capillary transfer line or injection loop, due to particulate matter from the sample. To clear the blockage:

Remove the probe from the source and increase the solvent flow to 50 $\mu\text{l}/\text{min}$ to remove the blockage.

Often, injections of neat formic acid help to redissolve any solute that has precipitated out of solution.

If the blockage cannot be cleared in this fashion:

Remove the finger-tight nut and tubing from the back of the probe.

If the backpressure remains high, replace the tubing with new tube (or first try removing both ends of the tube).

If the backpressure falls, renew the stainless steel sample tube inside the probe (or try reversing the tube to blow out any blockage).

Reconnect the tubing to the probe.

The solvent flow can be readjusted and the probe refitted into the source.

To check the flow rate from the solvent delivery system, fill a syringe barrel or a graduated glass capillary with the liquid emerging from the probe tip, and time a known volume, say 10 μl .

Once the rate has been measured and set, a note should be made of the backpressure readout on the pump, as fluctuation of this reading can indicate problems with the solvent flow.

For APcI, a higher than normal backpressure readout on the HPLC pump can imply that, after a long period of use, the filter pad requires replacement.

8.10.6 General Loss of Performance

Should the preceding checks fail to reveal the source of the problem proceed as follows:

Check that the source and probe voltage read-backs vary with tune page settings.

If any of these voltages are absent, check that the source and ion tunnel transfer lens assembly has been correctly reassembled.

Further investigations, which require the services of a qualified service engineer, should be left to Micromass personnel.

8.11 Cleaning Materials



Warning: Many of the procedures described in this chapter involve the removal of possibly toxic contaminating deposits using flammable or caustic agents. Personnel performing these operations should be aware of the inherent risks, and should take the necessary precautions.

When cleaning internal components, it is important to maintain the quality of the surface finish. Deep scratches or pits can cause loss of performance. Where no specific cleaning procedure is given, fine abrasives should be used to remove dirt from metal components. Recommended abrasives are:

- 600 and 1200 grade emery paper.
- Lapping paper (produced by 3M).

After cleaning with abrasives, it is necessary to wash all metal components in suitable solvents to remove all traces of grease and oil. The recommended procedure is to sonicate the components in a clean beaker of solvent and subsequently to blot them dry with lint-free tissue. Recommended solvents are:

- Isopropyl Alcohol (IPA).
- Methanol.
- Acetone.

Following re-assembly, components should be blown with oil-free nitrogen to remove dust particles.

8.12 Preventive Maintenance Check List



Caution: Avoid venting the instrument when the rotary pump is gas ballasting.



Caution: Do not gas ballast the rotary pump for more than 2 hours under any circumstances.

For full details of the following procedures, consult the relevant sections of this chapter and/or refer to the manufacturer's literature.

8.12.1 Weekly

- Gas ballast for at least 30 minutes by rotating the gas ballast knob anticlockwise by 5 to 6 turns.

When gas ballast is complete, check the rotary pump oil level and color.

Oil that has become noticeably red in color should be replaced.

- Check the water chiller level and temperature (if fitted).

8.12.2 Monthly

- Check all cooling fans and filters.
- Change the odor element in the oil mist filter.

8.12.3 Three-Monthly

- Change the sorbent in the foreline trap.

8.12.4 Four-Monthly

- Change the mist element in the oil mist filter.
- Change the oil in the rotary pump.

Gas ballast lightly for 30 to 60 minutes both before and after changing oil.

Appendix A

Reference Information

1.1 Overview

Calibration reference files consist of two columns of numbers separated by any number of spaces or TAB characters. The first column contains the reference peak masses and the second column contains the reference peak intensities.

The reference files listed in this chapter have all ion intensities set to 100%. Actual ion intensities are not, of course, all 100%, but the calibration software does not take account of the ion intensities and this is a convenient way to store the reference files in the required format. However, if required, realistic intensity values can be entered to improve the appearance of the reference spectra.

Most samples can be purchased from the Sigma chemical company. To order, contact Sigma via the Internet, or by toll-free (or collect) telephone or fax:

Internet:

<http://www.sigma.sial.com>

This site contains a list of world-wide Sigma offices, many with local toll-free numbers.

Toll-free telephone:

USA & Canada: 800-325-3010.

Outside USA & Canada: ++1 314-771-5750 (call collect).

Toll-free fax:

USA & Canada: 800-325-5052.

Outside USA & Canada: ++1 314-771-5750 (call collect and ask for the fax machine).

Outside USA & Canada: ++1 314-771-5757 (toll call) (direct fax line).

1.2 Editing a Reference File

Calibration reference files can be created or edited using any Windows text editor. To read the currently selected reference file into the Notepad text editor:

Select the  button, or select **Reference File** from the **Calibration, Edit** menu.

To save the reference file after editing either:

Select **Save** from the Notepad **File** menu to save the file under the current name.

Or:

Select **Save As** from the Notepad **File** menu to save as a new reference file with a new name.

Textual information or comments can be stored in the reference file. Lines which are textual information or comments must start with the semi-colon (;) character.

1.3 Positive Ion

Ref. File Name	Chemical Name [Sigma Code #]	Molecular Mass	m/z	Uses
UBQ	Bovine Ubiquitin [U6253]	8564.85	650-1500	General
HBA	Human α globin [H753]	15126.36	700-1500	Hb analysis
SOD	Superoxide dismutase [S2515]	15591.35	900-1500	Hb (internal cal.)
HBB	Human β globin [H7379]	15867.22	800-1500	Hb analysis
MYO	Horse heart myoglobin [M1882]	16951.48	700-1600	General
PEGH1000	Polyethylene glycol + ammonium acetate mixture PEG 200+400+600+1000		80-1000	ES+ and APcI+ calibration
PEGH2000	Polyethylene glycol + ammonium acetate mixture PEG 200+400+600+1000+1450		80-2000	ES+ calibration
NAICS	Sodium Iodide / Caesium Iodide mixture		20-4000	General, ES+ calibration
NAIRB	Sodium iodide / Rubidium Iodide mixture		20-4000	ES+ calibration

A

1.3.1 Horse Heart Myoglobin

Reference File: myo.ref, Molecular Weight: 16951.48

Charge State	Calculated m/z Value	Charge State	Calculated m/z Value	Charge State	Calculated m/z Value
28 ⁺	606.419	21 ⁺	808.222	13 ⁺	1304.969
	616.177	20 ⁺	848.583	12 ⁺	1413.633
27 ⁺	628.841	19 ⁺	893.192	11 ⁺	1542.053
26 ⁺	652.989	18 ⁺	942.758	10 ⁺	1696.158
25 ⁺	679.068	17 ⁺	998.155	9 ⁺	1884.508
24 ⁺	707.320	16 ⁺	1060.477	8 ⁺	2119.945
23 ⁺	738.030	15 ⁺	1131.108	7 ⁺	2422.651
22 ⁺	771.531	14 ⁺	1211.829		

1.3.2 Polyethylene Glycol

PEG + NH₄⁺

Reference Files: PEGH1000, PEGH2000.

Calculated m/z Value				
63.04	459.28	855.52	1251.75	1647.99
107.07	503.31	899.54	1295.78	1692.01
151.10	547.33	943.57	1339.80	1736.04
195.12	591.36	987.60	1383.83	1780.07
239.15	635.39	1031.62	1427.86	1824.09
283.18	679.41	1075.65	1471.88	1868.12
327.20	723.44	1119.67	1515.91	1912.15
371.23	767.46	1163.70	1559.94	1956.17
415.25	811.49	1207.73	1603.96	2000.20



1.3.3 Sodium Iodide and Caesium Iodide Mixture

Reference File: NAICS

Calculated m/z Value				
22.9898	772.4610	1671.8264	2571.1918	3470.5572
132.9054	922.3552	1821.7206	2721.0861	3620.4515
172.8840	1072.2494	1971.6149	2870.9803	3770.3457
322.7782	1222.1437	2121.5091	3020.8745	3920.2400
472.6725	1372.0379	2271.4033	3170.7688	
622.5667	1521.9321	2421.2976	3320.6630	

1.3.4 Sodium Iodide and Rubidium Iodide Mixture

Reference File: NAIRB

Calculated m/z Value				
22.9898	772.4610	1671.8264	2571.1918	3470.5572
84.9118	922.3552	1821.7206	2721.0861	3620.4515
172.8840	1072.2494	1971.6149	2870.9803	3770.3457
322.7782	1222.1437	2121.5091	3020.8745	3920.2400
472.6725	1372.0379	2271.4033	3170.7688	
622.5667	1521.9321	2421.2976	3320.6630	

1.4 Negative Ion

A

Ref. File Name	Chemical Name [Sigma Code #]	Molecular Mass	m/z	Uses
MYONEG	Horse heart myoglobin [M1882]	16951.48	700-2400	General
SUGNEG	Sugar mixture of: maltose [M5885] raffinose [R0250] maltotetraose [M8253] corn syrup [M3639]		100-1500	Low mass range
NAINEG	Sodium Iodide/Caesium Iodide (or Rubidium Iodide) mixture		200-3900	ES- calibration

1.4.5 Horse Heart Myoglobin

Reference File: myoneg.ref

Calculated m/z Value			
891.175		1209.812	1882.490
940.741		1302.952	2117.927
996.138		1411.615	2420.632
1058.460		1540.036	
1129.091		1694.140	

1.4.6 Mixture of Sugars

Reference File: sugneg.ref

Calculated m/z Value				
179.06		665.21		1151.37
341.11		827.27		1313.42
503.16		989.32		1475.48

1.4.7 Sodium Iodide and Caesium Iodide (or Rubidium Iodide) Mixture

Reference File: naineg.ref

Calculated m/z Value				
126.9045	1026.2699	1925.6353	2825.0008	3724.3662
276.7987	1176.1641	2075.5296	2974.8950	3874.2604
426.6929	1326.0584	2225.4238	3124.7892	
576.5872	1475.9526	2375.3180	3274.6835	
726.4814	1625.8469	2525.2123	3424.5777	
876.3757	1775.7411	2675.1065	3574.4719	

1.5 Preparation of Calibration Solutions

1.5.8 PEG + Ammonium Acetate for Positive Ion ElectroSpray and APcl

Prepare a solution of polyethylene glycols at the following concentrations:

PEG 200: 25 ng/ μ l.

PEG 400: 50 ng/ μ l.

PEG 600: 75 ng/ μ l.

PEG 1000: 250 ng/ μ l.

Use 50% acetonitrile and 50% water containing 2 mmol ammonium nitrate.

Use reference file PEGH1000.

1.5.9 PEG + Ammonium Acetate for Positive Ion ElectroSpray (Extended Mass Range)

Prepare a solution of polyethylene glycols at the following concentrations:

PEG 200: 25 ng/ μ l.

PEG 400: 50 ng/ μ l.

PEG 600: 75 ng/ μ l.

PEG 1000: 250 ng/ μ l.

PEG 1450: 250 ng/ μ l.

Use 50% acetonitrile and 50% water containing 2 mmol ammonium nitrate.

Use reference file PEGH2000.

1.5.10 Sodium Iodide Solution for Positive Ion ElectroSpray

Method 1

Prepare a solution of sodium iodide at a concentration of 2 $\mu\text{g}/\mu\text{l}$ (micrograms per microlitre) in 50:50 propan-2-ol (IPA):water with no additional acid or buffer.

Add caesium iodide to a concentration of 0.05 $\mu\text{g}/\mu\text{l}$.

The purpose of the caesium iodide is to obtain a peak at m/z 133 (Cs^+) to fill the gap in the calibration file between m/z 23 (Na^+) and the first cluster at m/z 173; this would otherwise lead to poor mass calibration in this mass range.

Do not add more CsI than suggested, as this may result in a more complex spectrum due to the formation of NaCsI clusters.

Use reference file NAICS.REF.

Method 2

Prepare a solution of sodium iodide at a concentration of 2 $\mu\text{g}/\mu\text{l}$ (micrograms per microlitre) in 50:50 propan-2-ol (IPA):water with no additional acid or buffer.

Add rubidium iodide to a concentration of 0.05 $\mu\text{g}/\mu\text{l}$.

The purpose of the rubidium iodide is to obtain a peak at m/z 85 ($^{85}\text{Rb}^+$) with an intensity of about 10% of the base peak at m/z 173. Rubidium iodide has the advantage that no rubidium clusters are formed which may complicate the spectrum. Note that rubidium has two isotopes (^{85}Rb and ^{87}Rb) in the ratio 2.59:1, giving peaks at m/z 85 and 87.

Use reference file NAIRB.REF.

1.5.11 Sodium Iodide Solution for Negative Ion ElectroSpray

Either of the above solutions is suitable for calibration in negative ion mode. In both cases the first negative reference peak appears at m/z 127 (I) and the remaining peaks are due to NaI clusters.

Use reference file NAINEG.REF.

Index

A

Acquisition
 Stopping 118
Adduct Mass dialog 157
Analog Channel Connections 44
Analog Data dialog 123
Analyzer Pressure
 Measuring 56
APcI
 Calibration 229
 Checking the Probe 226
 Hints for Sample Analysis 229
 Obtaining an Ion Beam 227
 Preparation 225
 Probe Position 228
 Renewing the Fused Silica Capillary
 260
 Tuning 229
APcI Probe
 Cleaning the Tip 258
 Maintenance 258
 Renewing the Probe Tip Heater 259
Atmospheric Pressure Chemical Ionization
 31, 223
Automatic Calibration Check dialog 164
Automatic Calibration dialog 168, 180, 186
Automatic Shutdown 71
Automatic Startup 71
AutoTune 96
AutoTune dialog 96
AutoTune Setup dialog 97

C

Calibration
 Atmospheric Pressure Chemical
 Ionization 183
 ElectroSpray 161
Calibration Acquisition Setup dialog 170,
 181, 187
Calibration dialog 163, 189
Calibration Failure 176
Calibration Options 163
Calibration Parameters dialog 165
Calibration Types 160
Capillary/Corona Connection 40
CE Profile dialog 150
Charge State Mass dialog 153
Charge State Recognition 154
Chromatogram Real-Time Update 111
CID Gas 46
Cleaning Materials 268
Collision Energy dialog 151
Collision Energy Ramp 100
Collision Ramp dialog 100
Complete Shutdown 70
Cone Gas 213
Cone Gas Nozzle and Sample Cone
 Cleaning 240
Cone Ramp dialog 99, 126
Cone Voltage Ramp 99
Configure Event In dialog 80
Constant Neutral Loss Spectrum 38
Contact Closure In Connections 44
Conventions, documentation 27
Corona Discharge Pin
 Cleaning 253
Customize Plot Appearance dialog 95

D

Data Acquisition 103
 Multiple Sample 107
 Starting from the Tune Page 103
Data System 38
Data System Connection 44
Daughter Ion Spectrum 34
Desolvation Gas 40, 212
Dialogs
 Adduct Mass 157
 Analog Data 123
 Automatic Calibration 168, 180, 186
 Automatic Calibration Check 164
 AutoTune 96
 AutoTune Setup 97
 Calibration 163, 189
 Calibration Acquisition Setup 170, 181,
 187
 Calibration Parameters 165
 CE Profile 150
 Charge State Mass 153
 Collision Energy 151
 Collision Ramp 100
 Cone Ramp 99, 126
 Configure Event In 80
 Customize Plot Appearance 95
 Display Calibration Graphs 190
 Display Verification Graphs 174
 Exclude Mass 146
 Function Switching Status 157
 Gas Threshold 79
 Include Masses 142
 Instrument Threshold Settings 113, 162
 Mass Measure 166
 Modify Charge State 153
 Quantify Samples 109
 Readbacks 102
 Scope Setup 98

Shutdown Log Parameters 75
Shutdown On Error Configuration 78
Solvent Delay 123
Spectrum Real-Time Update 111
Start Acquisition 103
Start Sample List Run 107
 System Manager 118
Display Calibration Graphs dialog 190
Display Verification Graphs dialog 174
Divert/Injection Valve 42
Documentation
 conventions 27

E

Electronics 47
ElectroSpray 31, 203
 Chromatographic Interfacing 220
 Obtaining an Ion Beam 210
 Operation 207
 Probe Position 211
 Sample Analysis and Calibration 218
 Tuning 210
ElectroSpray Operation
 Preparation for 57, 61
ElectroSpray Probe
 Maintenance 254
 Renewal of the Stainless Steel Sample
 Capillary 256
Emergency Shutdown 69
ESD Earth Facility 47
ESI/APCI Connection 40
Event Out Connections 43
Exclude Mass dialog 146
Exhausts 46

F

Fault Finding 233
 Check List 265
 Flow Control Valves 41
 Fragmentation 68
 Front Panel Connections 39
 Front Panel Controls and Indicators 40
 Full Scan Function 125
 Full Scan Function Editor 125
 Function Switching Status dialog 157
 Fuses 46, 263

G

Gas Controls 99
 Gas Threshold dialog 79

I

Include Masses dialog 142
 Instrument Data Thresholds 113
 Instrument Threshold Parameters 162
 Instrument Threshold Settings dialog 113,
 162
 Internal Layout 47
 Ion Block
 Cleaning 245
 Ion Mode 98
 Ion Tunnel Assembly
 Cleaning 249

M

Mains Switch 46
 Maintenance 233
 Analyzer 262
 APCI Probe 258
 Detector 262

ElectroSpray Probe 254
 Foreline Trap 237
 Gas Ballasting and Rotary Pump Oil
 Recirculation 236
 Magnetron Gauge 235
 Oil Mist Filter 237
 Pirani Gauge 235
 Rotary Pump Oil 238
 Source 239

Mass Calibration 159
 Mass Measure dialog 166
 MassLynx NT 38
 Mechanical Components 50
 MegaFlow ElectroSpray 206
 Megaflow Hints 217
 Modify Charge State dialog 153
 MRM Function 133
 MS Method Editor 118
 MS Method Editor Tool Bar 120
 MS Operating Modes 32
 MS-MS Operating Modes 33
 MS-MS Operation 67
 MS-MS Scanning Functions 130
 Multiple Reaction Monitoring 36
 MUX Connection 44

N

NanoFlow ElectroSpray 32
 Nebuliser Gas 212
 Nitrogen Gas In Connection 45

O

Obtaining an Ion Beam
 APCI 227
 ElectroSpray 210
 Operate LED 41
 Overnight Shutdown 69

P

Parent Ion Selection 67
 Parent Ion Spectrum 35
 Post-column Splitting 205
 Power Cord 46
 Power Failure 66
 Preventive Maintenance
 Check List 269
 Probe Nebuliser Gas 40
 Probe Position
 APcI 228
 ElectroSpray 211
 Pump Fault 65
 Pumping and Vacuum Protection 64
 Purge Gas 214

Q

Quantify Samples dialog 109

R

Ramp Controls 99
 Readbacks
 Controlling 102
 Readbacks dialog 102
 Rear Panel Connections 43
 Reference File
 Editing 272
 Reference Information 271
 Restrictor 214
 Rotary Pump Control 46

S

Sample Inlet 32
 Scan Report window 110
 Scan Speed Compensation 195

Scanning Calibration 195
 Scope Parameters 98
 Scope Setup dialog 98
 Shutdown
 Automatic 71
 Complete 70
 Emergency 69
 Overnight 69
 Shutdown Editor 71
 Auto Control Tasks Page 82
 Menu Bar 72
 Shutdown Page 76
 Shutdown Editor Tool Bar 76
 Shutdown Log Parameters dialog 75
 Shutdown On Error Configuration dialog 78
 Shutdown Procedures 69
 SIR Function 128
 Solvent Delay dialog 123
 Source Voltages 89
 Spectrum Real-Time Update 111
 Spectrum Real-Time Update dialog 111
 Spike Removal 116
 Start Acquisition dialog 103
 Start Sample List Run dialog 107
 Start Up 51, 57, 66
 Startup 57
 Automatic 71
 Status Display 41
 Survey Function 133
 Survey Scan Dialog
 Adduct Page 156
 Collision Energy Page 148
 Exclude Page 145
 Include Page 140
 MS to MSMS Page 135
 MSMS to MS Page 138
 Survey and MSMS Template Pages 134
 Survey Scan dialog 133
 System Manager dialog 118

T

Transient Pressure Trip 65

Tune Page 88

Tune Parameter Settings

Restoring 91

Saving 91

Tune Peak Display

Modifying 92

Tuning 87

APcI 229

ElectroSpray 210

V

Vacuum LED 41

Vacuum System 30

W

Water Connection 45

